

SK513

COM Express® Type 6 Carroer Board +
MXM Graphics System + PCIe/104

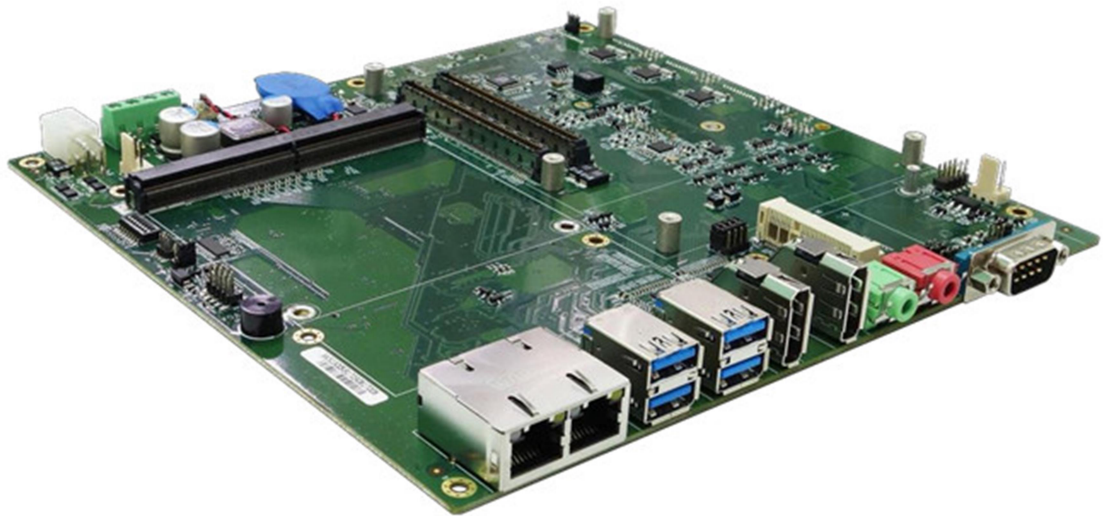

Safety Information

Electrical safety

- To prevent electrical shock hazard, disconnect the power cable from the electrical outlet before relocating the system.
- When adding or removing devices to or from the system, ensure that the power cables for the devices are unplugged before the signal cables are connected. If possible, disconnect all power cables from the existing system before you add a device.
- Before connecting or removing signal cables from the motherboard, ensure that all power cables are unplugged.
- Seek professional assistance before using an adapter or extension cord. These devices could interrupt the grounding circuit.
- Make sure that your power supply is set to the correct voltage in your area.
- If you are not sure about the voltage of the electrical outlet you are using, contact your local power company.
- If the power supply is broken, do not try to fix it by yourself. Contact a qualified service technician or your local distributor.

Operation safety

- Before installing the motherboard and adding devices on it, carefully read all the manuals that came with the package.
- Before using the product, make sure all cables are correctly connected and the power cables are not damaged. If you detect any damage, contact your dealer immediately.
- To avoid short circuits, keep paper clips, screws, and staples away from connectors, slots, sockets and circuitry.
- Avoid dust, humidity, and temperature extremes. Do not place the product in any area where it may become wet.
- Place the product on a stable surface.
- If you encounter any technical problems with the product, contact your local distributor

Statement

- All rights reserved. No part of this publication may be reproduced in any form or by any means, without prior written permission from the publisher.
- All trademarks are the properties of the respective owners.
- All product specifications are subject to change without prior notice

Revision History

Revision	Date (yyyy/mm/dd)	Changes
V1.0	2019.10.01	Initial Release
V1.1	2022.03.01	Add Standard Compliance 、 OS
V1.2	2022.03.14	1.Modify COM ExpressCPU Options(Type 6/7) 2.Modify GPU Module Options
V1.3	2022.11.24	Modify RS485 Pin define

Table of Contents

Safety Information	1
Electrical safety.....	1
Operation safety	1
Statement.....	1
Revision History	1
Packing list	1
Ordering Information	1
Chapter 1: Product Information	5
1.1 Key Features	5
1.2 Block Diagram	7
1.3 GPU Options	8
1.4 Connector & Pin Header	9
Chapter 2: Jumpers and Connectors	11
2.1 Connector & Pin Definitions	11
COM1	11
COM12,CN13(Mic-in / Line-out)	11
DP1,DP2(Display Port)	11
CN17,CN23(USB3.0)	11
CN25(LAN1,LAN2)	12
JP7(COM1 Pin9 Select).....	12
JP8,JP9(COM1 Mode Select)	12
JP10(Enable COM1 RS-485/422 Receiver Termination)	12
J22,J25(FAN Connector)	13
J23 (Front Panel).....	13
CN1,CN2 (COM Express Connector).....	13
CN15: M_PClE2 (Mini PCIe Slot)....	13
JP6 (Mini PCIe Function Select)....	14
J20 (MXM_VGA).....	14
JP30 (MXM Type Select).....	14
MXM1(MXM Socket).....	14
CN21 (MXM DC-IN).....	14
JP28 (Clear CMOS).....	15

DC-IN(System DC-IN)..... 15

J18: MXM_DP(C/D)..... 15

J17: MXM_DP(A/B)..... 15

J10 (LVDS)..... 16

SIM_CARD1..... 16

J15: USB2.0(USB4/USB5)..... 16

J8 (VGA)..... 16

J9 (DIO)..... 17

J11 (LVDS Backlight)..... 17

JP23 (LVDS Backlight Power Select)..... 17

J24 (LVDS Signal Power Select)..... 17

No31: LPC/COM2/3/4..... 18

J4 (LPC)..... 18

J5: COM2 / J6: COM3 / J13: COM4..... 18

JP12, JP13(COM2 Mode Select)..... 19

JP14(Enable COM2 RS-485/422 Receiver Termination)..... 19

JP11(COM2 Pin9 Select)..... 19

JP16,JP17(COM3 Mode Select)..... 19

JP18(Enable COM3 RS-485/422 Receiver Termination)..... 19

JP15(COM3 Pin9 Select)..... 19

JP20,JP21(COM4 Mode Select)..... 20

JP22(Enable COM4 RS-485-422 Receiver Termination)..... 20

JP19(COM4 Pin9 Select)..... 20

CN26,CN27(SATA)..... 20

J2, J3 (SATA Power)..... 20

CN14: M_PCl e1(Mini PCIe Slot)..... 20

CN3: M.2(2280 M-key, SATA Only)..... 21

CN36(Stack PC1)..... 21

Chapter 1 : Product Introduction

1.1 Specifications

System

COM Express CPU Options (Type 6)	<p>Intel® Core™ i7-12800HE 45W Alder Lake 12th Gen, 14C , Freq. 3.5 /4.6 GHz, 24MB cache</p> <p>Intel® Core™ i7-11850HE 45W Tiger Lake 11th Gen, 8C , Freq. 2.6 /4.7 GHz, 24MB cache</p> <p>Intel® Xeon® W-11865MLE 45W Coffee Lake 11th Gen, 8C , Freq. 1.5 /4.5 GHz, 12MB cache</p> <p>Intel® Xeon® E-2276ME 45W Coffee Lake 9th Gen, 6C , Freq. 2.8 /4.5 GHz, 12MB cache</p> <p>Intel® Xeon® E-2276ML 25W Coffee Lake 9th Gen, 6C , Freq. 2.0 / 4.2 GHz, 12MB cache</p> <p>Intel® Core™ i7-9850HE 45W Coffee Lake 9th Gen, 6C, Freq. 2.7 / 4.4 GHz, 9MB cache</p> <p>Intel® Core™ i7-9850HL 25W Coffee Lake 9th Gen, 6C, Freq. 1.9 / 4.1 GHz, 9MB cache</p> <p>Intel® Core™ i7-7820EQ 45W Kaby Lake 7th Gen, 4C, Freq. 3.0 / 3.7 GHz, 8MB cache</p> <p>Intel® Xeon® E3-1505L v6 25W Sky Lake 6th Gen, 4C, Freq. 2.2 / 3.0 GHz, 8MB cache</p>
COM Express CPU Options (Type 7)	<p>Intel® Xeon®-D1577 45W Broadwell-DE, 16C, Freq. 1.3 / 2.1 GHz, 24MB cache</p> <p>Intel® Xeon®-D1559 45W Broadwell-DE, 16C, Freq. 1.5 / 2.1 GHz, 18MB cache (eTEMP)</p>
GPU Module Options	<p>NVIDIA® GeForce™ GTX 1050Ti, 60W, 4GB GDDR5, 768 CUDA Cores</p> <p>NVIDIA® GeForce™ RTX 2060S, 175W, 8GB GDDR6, 2176 CUDA Cores</p> <p>NVIDIA® Quadro™ RTX 5000, 150W, 16GB GDDR6, 3072 CUDA Cores</p> <p>NVIDIA® Quadro™ RTX 3000, 80W, 6GB GDDR6, 1920 CUDA Cores</p>
COM Express Compatibility	COM Express® Type 6/7

Expansion

MiniPCIe Expansion	2 x Full-size mini PCIe (1 with mSATA supported)
M.2 Expansion	1 x 2280 M-key (SATA only)
PCIe/104 Expansion	4 x PCIe x 1 、 1 x PCIe x 4 、 5 x USB 2.0 、 1 x LPC 、 1 x SPI
SATAIII	2 x SATAIII

Display

Display Port	2 x Display Port outputs from COM Express®, 4 x outputs from GPU, 6 total
VGA	1 x output from COM Express®, 1 x output from GPU
LVDS	1 x dual channel 18/24bit LVDS
DVI	1

Ethernet

Gigabit Ethernet	2 x 10/100/1000 Ethernet Ports
------------------	--------------------------------

I/O

USB	4 x USB 3.0, 2 x USB 2.0
-----	--------------------------

COM Port	4 x RS232/422/485
----------	-------------------

Audio	1 x Line-out, 1 x Mic-In
-------	--------------------------

Power System

Input Power_SYS	9~36V (4P Terminal Block)
-----------------	---------------------------

Input Power_MXM	12V (ATX 4P)
-----------------	--------------

Power Consumption	Varies per COM Express /MXM with different CPU and GPU models
-------------------	---

RTC Battery	3V CR2032
-------------	-----------

Mechanical and Environmental

Dimension	190mm x 185mm
-----------	---------------

Operation Temperature	-40 to 85°C
-----------------------	-------------

Storage Temperature	-40 to 85°C
---------------------	-------------

Relative Humidity	10% to 90%, non-condensing
-------------------	----------------------------

Standard Compliance

Standart Compliance	CE / FCC
---------------------	----------

OS

OS Support	Windows®10 64bit Linux(Support by request)
------------	---

***All specifications and photos are subject to change without notice.**

1.2 Board Placement

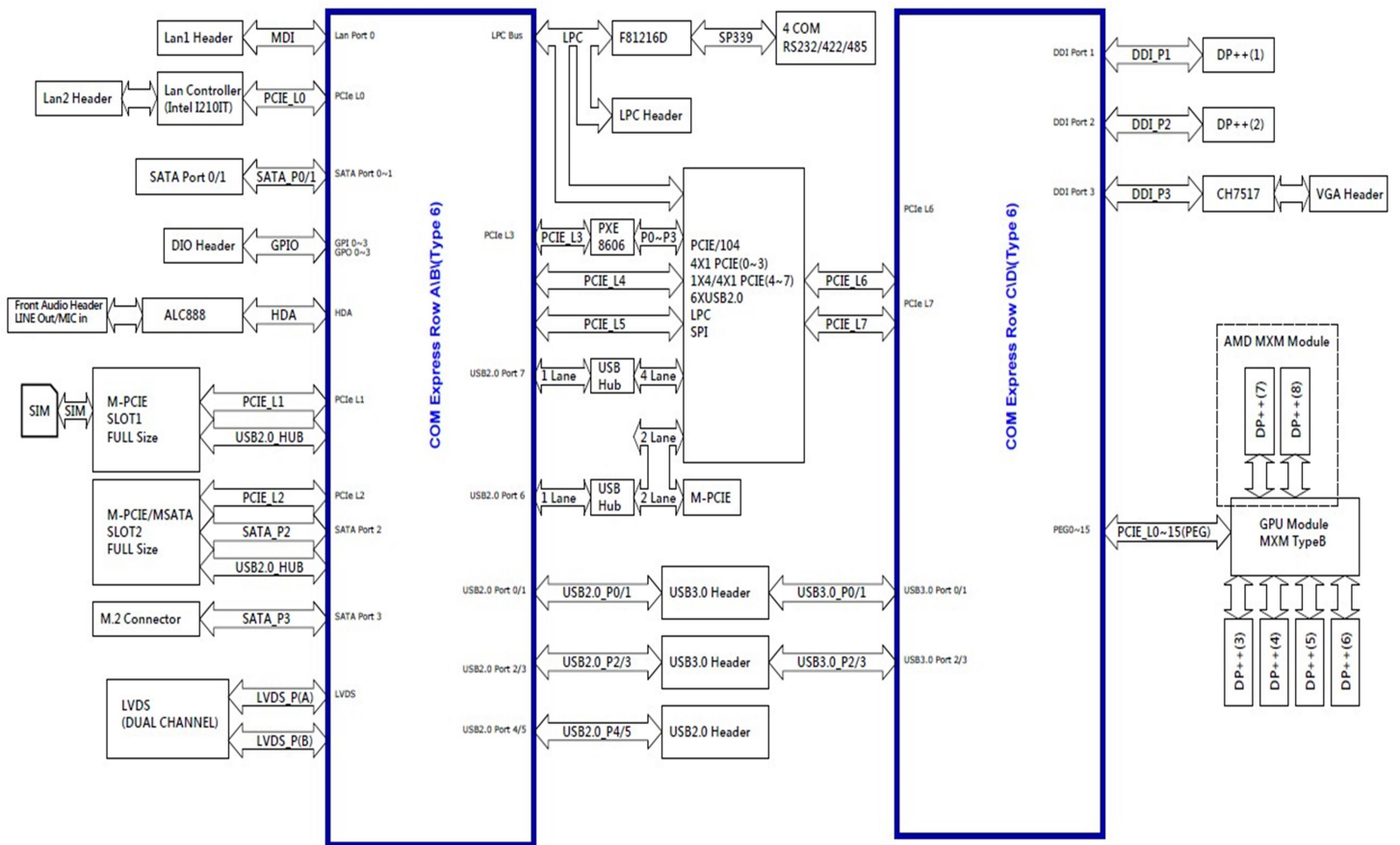

1.3 GPU Options

The SK513 has multiple GPUs available. These have different specifications, as detailed below:

NVIDIA GeForce™

	950	1050	1050Ti
CUDA Cores	640	640	768
Processor Clock (Base)	914 MHZ	1354 MHZ	1493 MHZ
Processor Clock (Boost)	1107 MHZ	1493 MHZ	1620 MHZ
Memory Size	2 GB	4 GB	4 GB
Memory Type	GDDR5	GDDR5	GDDR5
Memory Clock	2.5 Gbps	7 Gbps	7 Gbps
Memory Interface	128-bit	128-bit	128-bit
Memory Bandwidth	80 GB/s	112 GB/s	112 GB/s
Output Channels	3	4	4
Power Draw	55W	50W	60W
Single Precision Compute Power	1170 GFLOPS	1.73 TFLOPS	2.29 TFLOPS
Open CL	1.1	1.2	1.2
Open GL	4.4	4.5	4.5
DirectX	11	12	12
PCI Express Gen	3.0	3.0	3.0
PCI Express Link Width	x16	x16	x16
Operational Temperature Range	0°C ~ +55°C	0°C ~ +55°C	0°C ~ +55°C

	1060	1070	1080
CUDA Cores	1280	2048	2560
Processor Clock (Base)	1404 MHZ	1442 MHZ	1556 MHZ
Processor Clock (Boost)	1670 MHZ	1645 MHZ	1733 MHZ
Memory Size	6 GB	8 GB	8 GB
Memory Type	GDDR5	GDDR5	GDDR5X
Memory Clock	8 Gbps	8 Gbps	10 Gbps
Memory Interface	192-bit	256-bit	256-bit
Memory Bandwidth	192 GB/s	256 GB/s	320 GB/s
Output Channels	4	4	4
Power Draw	78W	115W	150W
Single Precision Compute Power	3.59 TFLOPS	5.9 TFLOPS	7.96 TFLOPS
Open CL	1.2	1.2	1.2
Open GL	4.5	4.5	4.5
DirectX	12	12	12
PCI Express Gen	3.0	3.0	3.0
PCI Express Link Width	x16	x16	x16
Operational Temperature Range	0°C ~ +55°C	0°C ~ +55°C	0°C ~ +55°C

1.4 Connector & Pin Header

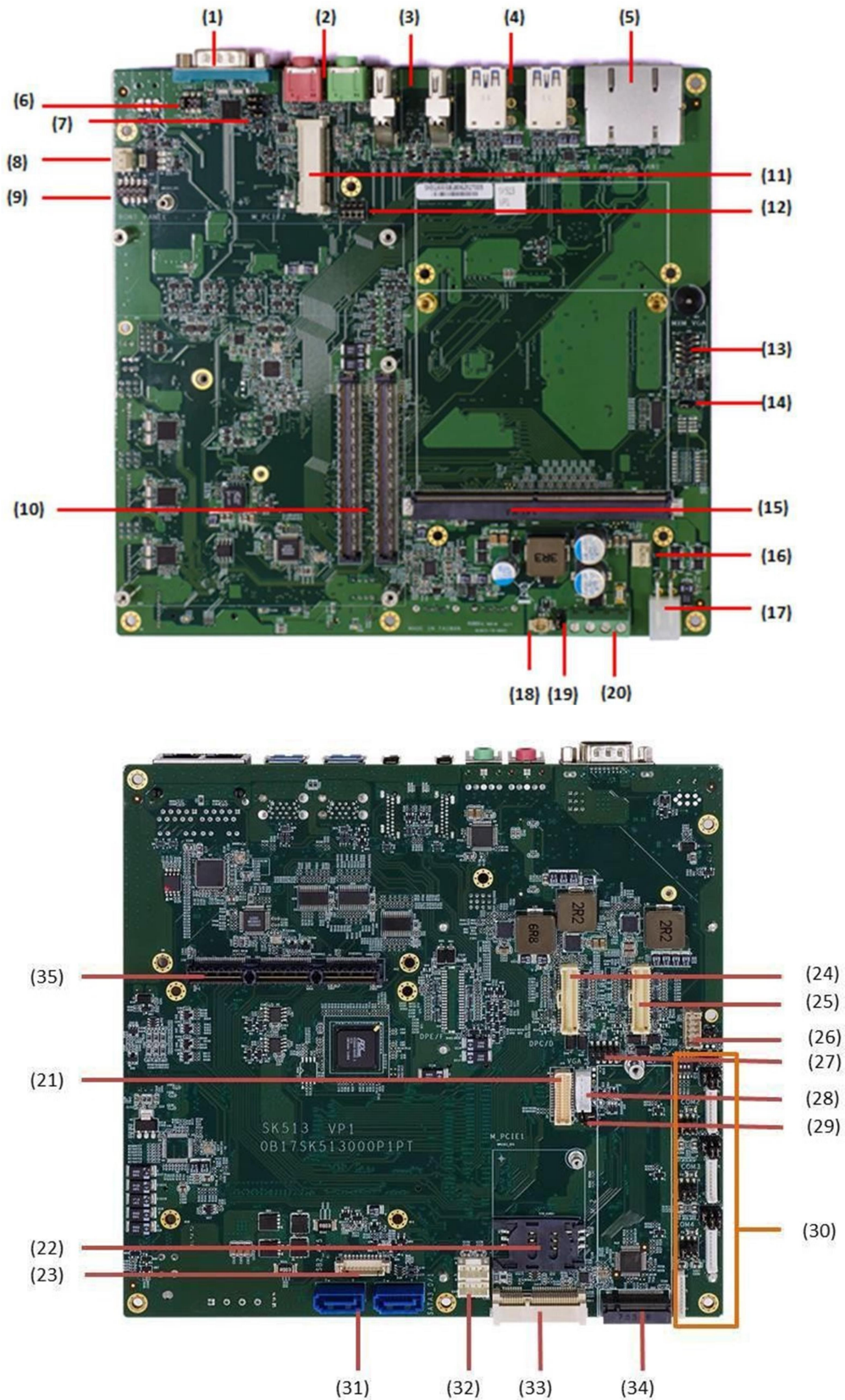

1	COM1
2	CN12 (MIC-In), CN13 (LINE-Out)
3	DP1, DP2
4	CN17, CN23 (USB3.0)
5	CN25 (LAN1, LAN2)
6	JP7
7	JP8,JP9,JP10
8	J22
9	J23
10	CN1, CN2 (COM Express connector)
11	CN15 (miniPCle)
12	JP6
13	J20
14	JP30
15	MXM1
16	J25
17	CN21
18	JBAT1
19	JP28
20	DCIN
21	J10
22	SIM_CARD1
23	J15
24	J18 (DPC/D)
25	J17 (DPA/B)
26	J9
27	J8
28	J11
29	JP23, JP24
30	See page 8~9
31	CN26, CN27
32	J2, J3
33	CN14
34	CN3
35	STACKPC1

Chapter 2 : Jumpers and Connectors

2.1 Connector & Pin Definitions

COM1

Pin	RS-232	RS-422	RS-485
1	DCD-	TX-	NC
2	RXD	TX+	NC
3	TXD	RX+	DATA+
4	DTR-	RX-	DATA-
5	GND	GND	GND
6	DSR-	NC	NC
7	RTS-	NC	NC
8	CTS-	NC	NC
9	RI	NC	NC

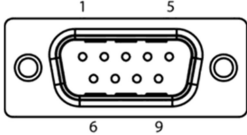

CN12,CN13: MIC-IN,LINE-OUT

	Definition
CN12	MIC-IN
CN13	LINE-OUT



DP1, DP2: Display Port

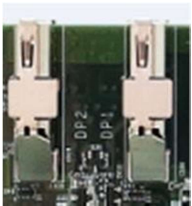

CN17, CN23: 4 x USB 3.0 Port

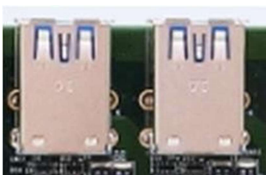

CN25: LAN1, LAN2

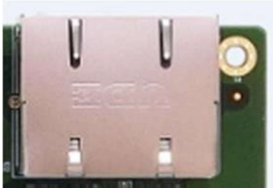

JP7: COM1 Pin9 select

Pin	Function
(1-2) Closed	RI
(3-4) Closed	+5V
(5-6) Closed	+12V

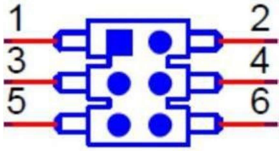

JP8, JP9: COM1 Mode select

JP8	JP9	Mode
(2-3)	(2-3)	RS232
(1-2)	(2-3)	RS485 Half Duplex
(1-2)	(1-2)	RS485/422 Full Duplex

JP10: Enable COM1 RS-485/422 Receiver Termination

Pin	Function
(1-2) Closed	High
(2-3) Closed	Low

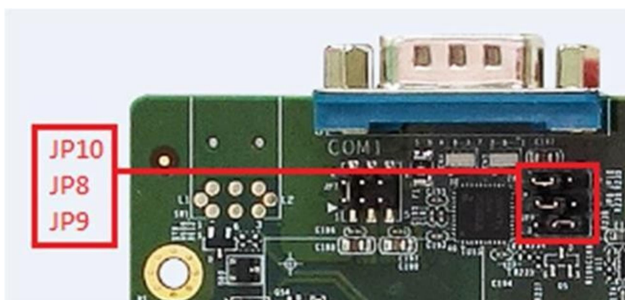

J22: CPU FAN Connector

Pin	Function
1	GND
2	CPUFANOUT
3	+12V

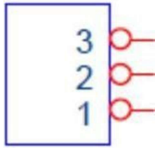

J25: MXM FAN connector

Pin	Function
1	GND
2	
3	+12V

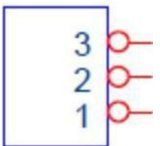

J23: Front Panel

Pin	Function
1	HDLED+
2	PWLED+
3	HDLED-
4	GND
5	GND
6	PWRBTN#
7	RESET
8	GND
9	NC

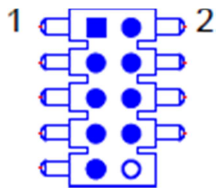

CN1,CN2: COM Express Connector

Support COM Express Basic Size Type 6 Module

CN15: M_PCIE2 (mini PCIe Slot)

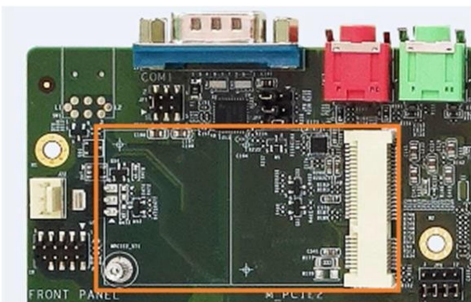

JP6: mini PCIe1 function select

PClex1	SATA
(1-2) Closed	(2-3) Closed



J20: MXM_VGA

Pin	Function
1	MVGA_VS
2	MVGA_SCL
3	MVGA_HS
4	MVGA_SDA
5	GND
6	MVGA_VCC
7	MVGA_R
8	MVGA_B
9	MVGA_G

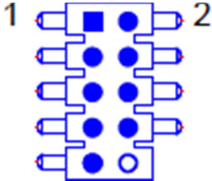

JP30: MXM Type select

Pin	Function
(1-2) Closed	MXM v3.0
(2-3) Closed	MXM v3.1

MXM1: MXM socket



CN21: MXM DC-IN

Pin	Definition
1	12V
2	12V
3	GND
4	GND

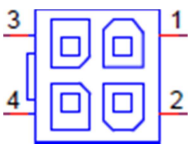

JP28: Clear CMOS

Pin	Function
(1-2) Closed	Normal(default)
(3-4) Closed	Clear CMOS

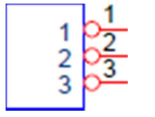

DCIN: System DC-IN

Pin	Definition
1	12V
2	12V
3	GND
4	GND



J18: MXM_DP(C/D)

Pin	Function	Pin	Function	Pin	Function	Pin	Function
1	GND	11	DPC_TN1	21	DPC_TP3	31	DPC_AUXP_CLK
2	GND	12	DPD_TN1	22	DPD_TP3	32	DPD_AUXP_CLK
3	DPC_TP0	13	GND	23	DPC_TN3	33	DPC_AUXN_DAT
4	DPD_TP0	14	GND	24	DPD_TN3	34	DPD_AUXN_DAT
5	DPC_TN0	15	DPC_TP2	25	GND	35	GND
6	DPD_TN0	16	DPD_TP2	26	GND	36	GND
7	GND	17	DPC_TN2	27	DPC_AUX_SEL	37	DPC_DET
8	GND	18	DPD_TN2	28	DPD_AUX_SEL	38	DPD_DET
9	DPC_TP1	19	GND	29	GND	39	DPC_PWR
10	DPD_TP1	20	GND	30	GND	40	DPD_PWR



J17: MXM_DP(A/B)

Pin	Function	Pin	Function	Pin	Function	Pin	Function
1	GND	11	DPA_TN1	21	DPA_TP3	31	DPA_AUXP_CLK
2	GND	12	DPB_TN1	22	DPB_TP3	32	DPB_AUXP_CLK
3	DPA_TP0	13	GND	23	DPA_TN3	33	DPA_AUXN_DAT
4	DPB_TP0	14	GND	24	DPB_TN3	34	DPB_AUXN_DAT
5	DPA_TN0	15	DPA_TP2	25	GND	35	GND
6	DPB_TN0	16	DPB_TP2	26	GND	36	GND
7	GND	17	DPA_TN2	27	DPA_AUX_SEL	37	DPA_DET
8	GND	18	DPB_TN2	28	DPB_AUX_SEL	38	DPB_DET
9	DPA_TP1	19	GND	29	GND	39	DPA_PWR
10	DPB_TP1	20	GND	30	GND	40	DPB_PWR



J10: LVDS

Pin	Function	Pin	Function	Pin	Function
1	LVDSB_CLK+	11	LVDSB2+	21	LVDSB0-
2	GND	12	LVDSA_CLK-	22	LVDSA1-
3	LVDSB_CLK	13	LVDSB2-	23	GND
4	LVDSA3+	14	GND	24	LVDSA0+
5	GND	15	LVDSB1+	25	LVDS_SCLK
6	LVDSA3-	16	LVDSA2+	26	LVDSA0-
7	LVDSB3+	17	LVDSB1-	27	LVDS_SDATA
8	GND	18	LVDSA2-	28	GND
9	LVDSB3-	19	LVDSB0+	29	LVDS_VCC
10	LVDSA_CLK+	20	LVDSA1+	30	LVDS_VCC



SIM_CARD1

Pin	Function	Pin	Function
1	UIM_PWR	4	GND
2	UIM_RESET	5	UIM_VPP
3	UIM_CLK_R	6	UIM_DATA



J15: USB2.0 (USB4/USB5)

Pin	Function	Pin	Function
1	5V_USB4	6	5V_USB5
2	USB2_DN4	7	USB2_DN5
3	USB2_DP4	8	USB2_DP5
4	GND	9	GND
5	GND	10	GND



J8: VGA

Pin	Function
1	VGA_VS
2	VGA_SCL
3	VGA_HS
4	VGA_SDA
5	GND
6	VGA_VCC
7	VGA_R
8	VGA_B
9	VGA_G

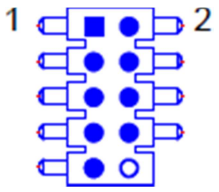

J9: DIO

Pin	Function
1	GPI0
2	GPO0
3	GPI1
4	GPO1
5	GPI2
6	GPO2
7	GPI3
8	GPO3
9	5V
10	GND

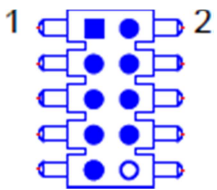

J11: LVDS Backlight

Pin	Function
1	BKL_VOL
2	LBKLT_CTRL
3	GND
4	GND
5	Backlight_EN



JP23: LVDS Backlight Power select

Pin	Function
(1-2) Closed	5V
(2-3) Closed	12V

JP24: LVDS Signal Power select

Pin	Function
(1-2) Closed	5V
(2-3) Closed	3.3V

No31: LPC/COM2/3/4

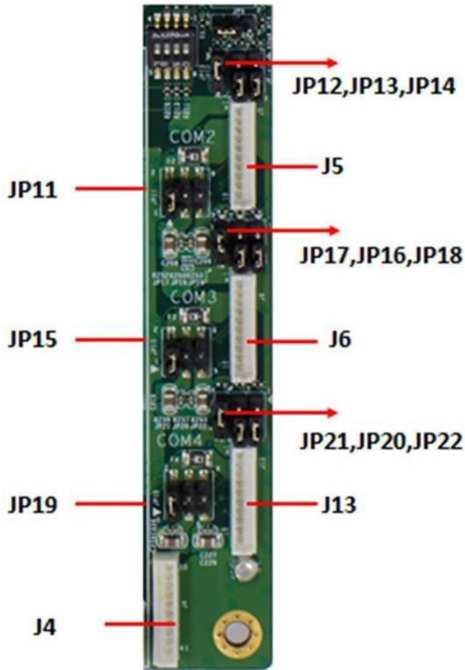

J4: LPC

Pin	Function
1	GND
2	GND
3	3V3
4	LPC_AD0
5	LPC_AD1
6	LPC_AD2
7	LPC_AD3
8	LPC_FRAME-
9	LPC_RST#
10	CLK_DBG

J5: COM2 / J6: COM3 / J13: COM4

Pin	RS232	RS422	RS485
1	5V	NC	NC
2	GND	GND	GND
3	COM_P9	NC	NC
4	DTR-	RX-	NC
5	CTS-	NC	NC
6	TXD	RX+	NC
7	RTS-	NC	NC
8	RXD	TX+	Data+
9	DSR-	NC	NC
10	DCD-	TX-	Data-

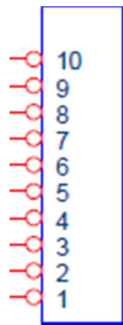

JP12, JP13: COM2 Mode select

JP8	JP9	Mode
(2-3)	(2-3)	RS232
(1-2)	(2-3)	RS485 Half Duplex
(1-2)	(1-2)	RS485/422 Full Duplex

JP14: Enable COM2 RS-485/422 Receiver Termination

Pin	Function
(1-2) Closed	High
(2-3) Closed	Low

JP11: COM2 Pin9 select

Pin	Function
(1-2) Closed	RI
(3-4) Closed	+5V
(5-6) Closed	+12V



JP16, JP17: COM3 Mode select

JP8	JP9	Mode
(2-3)	(2-3)	RS232
(1-2)	(2-3)	RS485 Half Duplex
(1-2)	(1-2)	RS485/422 Full Duplex

JP18: Enable COM3 RS-485/422 Receiver Termination

Pin	Function
(1-2) Closed	High

(2-3) Closed	Low
--------------	-----

JP15: COM3 Pin9 select

Pin	Function
(1-2) Closed	RI
(3-4) Closed	+5V
(5-6) Closed	+12V

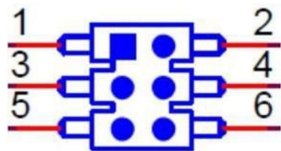

JP20, JP21: COM4 Mode select

JP8	JP9	Mode
(2-3)	(2-3)	RS232
(1-2)	(2-3)	RS485 Half Duplex
(1-2)	(1-2)	RS485/422 Full Duplex

JP22: Enable COM4 RS-485/422 Receiver Termination

Pin	Function
(1-2) Closed	High
(2-3) Closed	Low

JP19: COM4 Pin9 select

Pin	Function
(1-2) Closed	RI
(3-4) Closed	+5V
(5-6) Closed	+12V

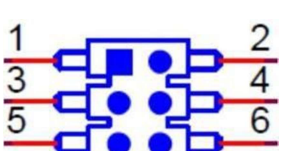

CN26,CN27: SATA

Pin	Function
1	GND
2	SATA_TP
3	SATA_TN
4	GND
5	SATA_RN
6	SATA_RP
7	GND



J2, J3: SATAPower

Pin	Definition
1	12V
2	GND
3	GND
4	5V



CN14: M_PCIE1 (mini PCIe Slot)

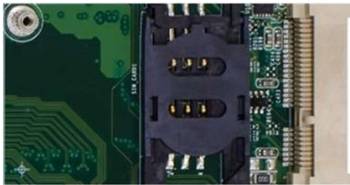

CN3: M.2 (2280 M-key, SATA only)

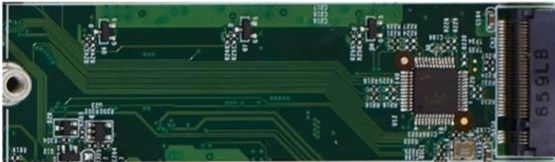

CN36: Stack PC1

