

Safety information

Electrical safety

- To prevent electrical shock hazard, disconnect the power cable from the electrical outlet before relocating the system.
- When adding or removing devices to or from the system, ensure that the power cables for the devices are unplugged before the signal cables are connected. If possible, disconnect all power cables from the existing system before you add a device.
- Before connecting or removing signal cables from the motherboard, ensure that all power cables are unplugged.
- Seek professional assistance before using an adapter or extension cord. These devices could interrupt the grounding circuit.
- Make sure that your power supply is set to the correct voltage in your area.
- If you are not sure about the voltage of the electrical outlet you are using, contact your local power company.
- If the power supply is broken, do not try to fix it by yourself. Contact a qualified service technician or your local distributor.

Operation safety

- Before installing the motherboard and adding devices on it, carefully read all the manuals that came with the package.
- Before using the product, make sure all cables are correctly connected and the power cables are not damaged. If you detect any damage, contact your dealer immediately.
- To avoid short circuits, keep paper clips, screws, and staples away from connectors, slots, sockets and circuitry.
- Avoid dust, humidity, and temperature extremes. Do not place the product in any area where it may become wet.
- Place the product on a stable surface.
- If you encounter any technical problems with the product, contact your local distributor

Statement

- All rights reserved. No part of this publication may be reproduced in any form or by any means, without prior written permission from the publisher.
- All trademarks are the properties of the respective owners.
- All product specifications are subject to change without prior notice

Revision History

Revision	Date (yyyy/mm/dd)	Changes
V1.0	2014/7/15	Initial release
V1.1	2014/8/8	Update for system information
V1.2	2014/09/19	1. Change BRACKET EAR-2, BRACKET EAR-1 P/N 2. Add Screw Flower Flat Plating Ni White M3 L:4mm ø5.0*8pcs for screw the HDD/SSD (P/N: 0F0102500400000L)
V1.3	2015/09/08	Add memory module installation
V1.4	2017/04/25	Update I/O spec

Packing list

- 19" 1U Rack-mount Intel® QM77 Fanless Rugged System
 Accessories:

Item	P/N	Description	Q'ty
1	0P0600000003000L	Driver CD	1
2	0C1210122103100L	CONN DIP 1*3 P:5.0mm Pluggable terminal block Female	1
3	0R0100250160000L	Thermal pad GR-Hm 24.5x16.2mm T:0.3mm	1
4	0N0600000000000L	BRACKET EAR-L SPGC 280x43.4x21.3mm t:3mm	2
5	0N0600000000010L	BRACKET EAR-S SPGC 90x43.4x21.3mm t:3mm	2
6	0F0130600600000L	Screw cross circle Plating Ni White M4 L:6mm	10
7	0F0132700800000L	Screw Flat Plating Ni White M4 L:8mm	10
8	0F0102500400000L	Screw Flower Flat Plating Ni White M3 L:4mm	8



If any of the above items is damaged or missing, please contact your local distributor.

Ordering information

Model Number	Description
ROC235A-ET	Intel® QM77 Fanless Rugged System with Intel® Ivy Bridge Core™ i7/i5/i3 Processor, with 1xPCI & 1x PCIe Expansion, 9V to 24V DC-in, Wide Temp. (-20 to 70°C)
ROC235A-UT	Intel® QM77 Fanless Rugged System with Intel® Ivy Bridge Core™ i7/i5/i3 Processor, with 1xPCI & 1x PCIe Expansion, 9V to 24V DC-in, Wide Temp. (-40 to 70°C Optional)
Processor	
Intel® Core™ i7-3610QE Processor (6M Cache, 2.30 GHz), 45 W	
Intel® Core™ i5-3610ME Processor (3M Cache, 2.70GHz), 35W	
Intel® Core™ i3-3120ME Processor (3M Cache, 2.40 GHz), 35W	

Table of Contents

SAFETY INFORMATION	1
ELECTRICAL SAFETY.....	1
OPERATION SAFETY.....	1
STATEMENT.....	1
REVISION HISTORY	2
PACKING LIST	2
ORDERING INFORMATION	2
TABLE OF CONTENTS	3
CHAPTER 1: PRODUCT INTRODUCTION	5
1.1 KEY FEATURES.....	5
1.2 FRONT PANEL COMPONENTS.....	6
1.3 REAR PANEL COMPONENTS.....	6
1.4 MECHANICAL DIMENSIONS.....	7
CHAPTER 2: JUMPERS AND CONNECTORS	8
2.1 FRONT PANEL CONNECTOR PIN DEFINITIONS.....	8
USB Port: USB2.0.....	8
Status Indicators.....	8
2.2 Rear Panel Connector Pin Definitions.....	9
LAN1_USB12: USB3.0 port 0,1 and LAN connector 1.....	9
LAN2_USB34: USB3.0 port 3,4 and LAN connector 2.....	9
AUDIO1: LINE-OUT/MIC-IN.....	9
DVI-D: DVI-D.....	9
VGA: VGA.....	10
HDMI: HDMI.....	10
COM1: RS232/422/485 with +12V/+5V selection.....	10
MINI_MPCIE: Mini PCIe connector.....	11
2.3 INTERNAL CONNECTORS.....	12
SATA1, SATA2: Serial ATA 3.0 Connector.....	12
SATA3, SATA4: Serial ATA 2.0 Connector.....	12
SATAP0, SATAP1: SATA Power Connector.....	12
PCI: PCI.....	13
CHAPTER 3: SYSTEM SETUP	14
3.1 2.5" SATA HDD/SSD INSTALLATION.....	14
3.2 CPU INSTALLATION.....	16
3.3 MEMORY MODULE INSTALLATION.....	18
3.4 PCI RISER CARD INSTALLATION.....	19
3.5 RACK MOUNT BRACKET INSTALLATION.....	21
CHAPTER 4: AMI BIOS UTILITY	22
4.1 STARTING.....	22
4.2 NAVIGATION KEYS.....	22
4.3 MAIN MENU.....	23
4.4 ADVANCED MENU.....	24
4.4.1 ACPI Settings.....	25
4.4.2 CPU Configuration.....	26
4.4.3 SATA Configuration.....	28

4.4.4 Thermal Configuration	29
4.4.4.1 Platform thermal configuration	29
4.4.5 Intel Rapid Start Technology	30
4.4.6 Intel TXT(LT) Configuration	30
4.4.7 PCH-FW Configuration	31
4.4.8 Intel Anti-Theft Technology Configuration	31
4.4.9 AMT Configuration	32
4.4.10 USB Configuration	33
4.4.11 F81866 Super IO Configuration	35
4.4.12 F81866 H/W Monitor	36
4.4.13 Serial Port Console Redirection	37
4.4.14 CPU PPM Configuration	38
4.5 CHIPSET	39
4.5.1 PCH-IO Configuration	39
4.5.1.1 USB Configuration	41
4.5.1.2 PCH Azalia Configuration	42
4.5.2 System Agent (SA) Configuration	43
4.5.2.1 Graphics Configuration	44
4.5.2.2 Memory Configuration	45
4.6 BOOT SETTING	46
4.7 SECURITY	47
4.8 SAVE AND EXIT	47

Chapter 1: Product Introduction

1.1 Key Features

System	
CPU Type	Intel® 22nm Ivy Bridge Processor (Mobile) socket (rPGA988) Core™ i7-3610QE 2.3 GHz (6M Cache, 45W) Core™ i5-3610ME 2.7 GHz (3M Cache, 35W) Core™ i3-3120ME 2.4 GHz (3M Cache, 35W)
Chipset	Intel® QM77
Memory Type	2 x 204-pin SO-DIMM DDR3 1333/1600 MHz up to 16 GB
Expansion Slot	2 x PCI 1 x Mini PCIe
Storage Device	2 x 2.5" HDD/SSD Supports RAID 0,1
Front I/O	
Power Button	1
Power LED	1
HDD LED	1
LAN Status LED	2 sets
USB	2 x USB 2.0
Reset	1
Rear I/O	
VGA	1
DVI-D	1
HDMI	1
Ethernet	2 x RJ45
Audio	Mic-in, Line-out
COM	1x RS232/422/485 with 5V/12V selectable
USB	4 x USB 3.0
Pre-cut hole	1 x D-sub pre-cut hole
DC-in	1 x 3-pin Terminal Block
Mechanical & Environment	
Power Requirements	9V to 24V DC-in
Dimension (W x H x D)	440 x 44 x 380mm (17.32" x 1.73" x 14.96")
Operating Temp.	-20 to 70°C (ambient with air flow)
Storage Temp.	-20 to 80°C
Relative Humidity	10% to 90%, non-condensing
Certification	CE, FCC

Specifications are subject to change without notice

1.2 Front Panel Components



1	LAN Status LED
2	USB 2.0 x 2
3	HDD LED
4	Reset Button
5	Power LED
6	Power Button

1.3 Rear Panel Components

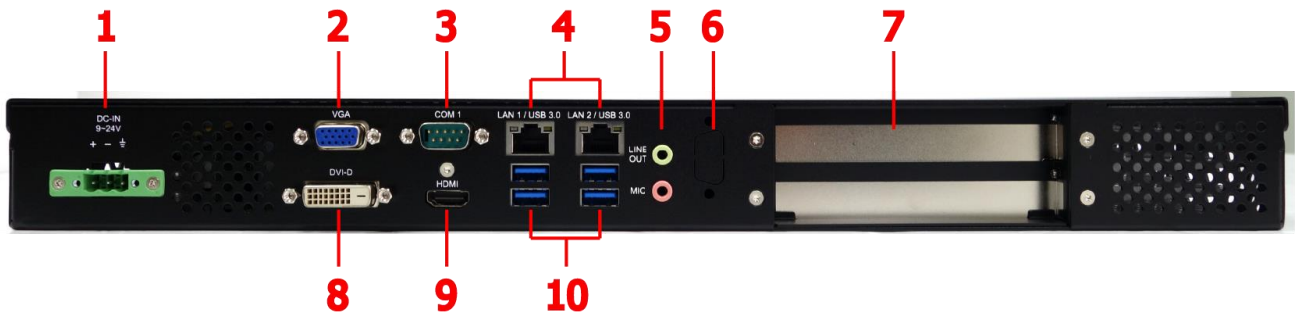

1	Power Input 9V to 24V DC-in (by terminal block)
2	VGA port
3	COM port, RS232/422/485 with 5V/12V selectable
4	LAN port, 2 x RJ45
5	Audio jack (Mic-in, Line-out)
6	Pre-cut hole for D-sub connector
7	2 x Expansion slot (PCI)
8	DVI-D port
9	HDMI port
10	4 x USB 3.0

1.4 Mechanical Dimensions

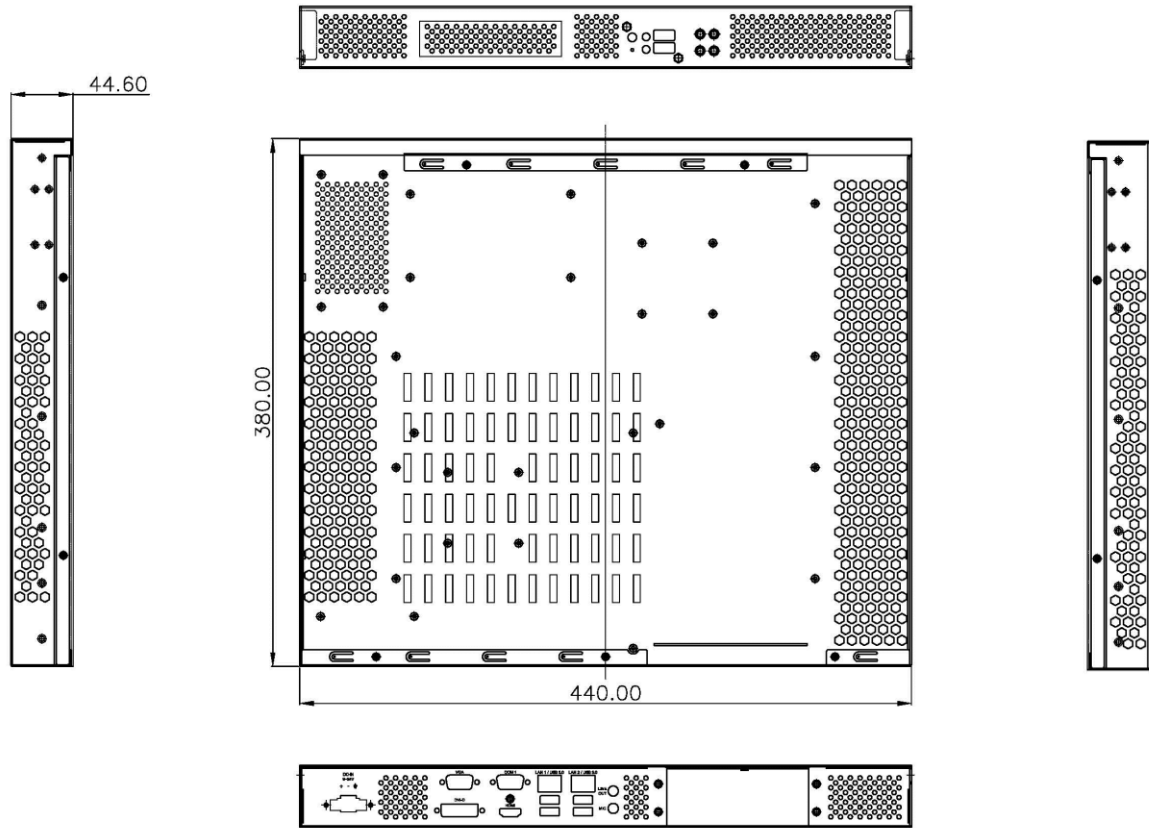

Chapter 2: Jumpers and Connectors



2.1 Front Panel Connector Pin Definitions

USB Port: USB2.0

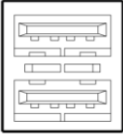







Pin	Definition	Pin	Definition
1	+5V	5	+5V
2	USBD-	6	USBD-
3	USBD+	7	USBD+
4	GND	8	GND



Status Indicators

Status	LED Color	
HDD	RED	<p>HDD</p>   <p>PWR</p>
PWR	BLUE	

SPEED LED:	ACTIVE 1 LED:	ACTIVE 2 LED:
RED: 1000Mbps	ORANGE (BLINKING): ACTIVITY	ORANGE (BLINKING): ACTIVITY
GREEN: 100Mbps	ORANGE (NO BLINKING): ACTIVITY	ORANGE (NO BLINKING): ACTIVITY

<p>ACT1</p>   <p>1000Mbps</p>	<p>ACT2</p>   <p>1000Mbps</p>	<p>ACT1</p>   <p>100Mbps</p>	<p>ACT2</p>   <p>100Mbps</p>
--	--	---	---

2.2 Rear Panel Connector Pin Definitions

LAN1_USB12: USB3.0 port 0,1 and LAN connector 1

LAN2_USB34: USB3.0 port 3,4 and LAN connector 2

Upper USB		Lower USB		LAN	
Pin	Definition	Pin	Definition	Pin	Definition
1	+5VDUAL	1	+5VDUAL	1	D0+
2	D-	2	D-	2	D0-
3	D+	3	D+	3	D1+
4	GND	4	GND	4	D1-
5	StdA_SSTX-	5	StdA_SSTX-	5	D2+
6	StdA_SSTX+	6	StdA_SSTX+	6	D2-
7	GND_DR1AN	7	GND_DR1AN	7	D3+
8	StdA_SSRX-	8	StdA_SSRX-	8	D3-
9	StdA_SSRX-	9	StdA_SSRX-		
SPEED LED: (Lift)			ACTIVE LED: (Right)		
GREEN: 1000Mbps			ORANGE (BLINKING): ACTIVITY		
ORANGE: 100Mbps			No Light: NOT LINK		
No Light: 10Mbps			ORANGE (NO BLINKING): LINK		

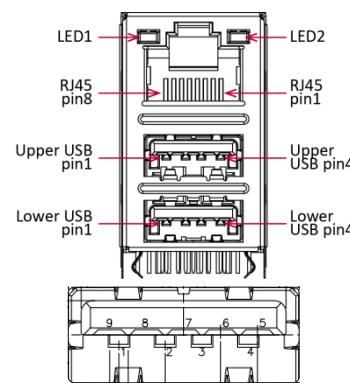
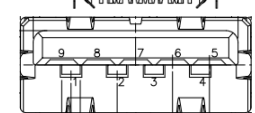
LED1 : LINK1000
LED2 : LINK100

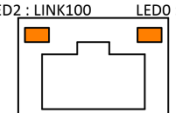

LED0 : LINK/ACTIVITY

AUDIO1: LINE-OUT/MIC-IN

Pin	Definition
1	Line-out
2	Mic-in

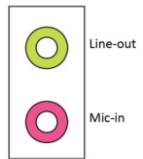

DVI-D: DVI-D

Pin	Definition	Pin	Definition
1	TMDS2-	13	NC
2	TMDS2+	14	+5V
3	GND	15	GND
4	NC	16	HOTPLUG_DETECT
5	NC	17	TMDS0-
6	DDC_CLK	18	TMDS0+
7	DDC_DATA	19	GND
8	NC	20	NC
9	TMDS1-	21	NC
10	TMDS1+	22	GND
11	GND	23	TMDSCLK+
12	NC	24	TMDSCLK-

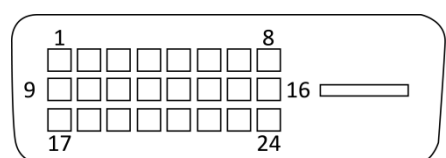

VGA: VGA

Pin	Definition	Pin	Definition
1	RED	9	+5V
2	GREEN	10	GND
3	BLUE	11	NC
4	NC	12	DDC DATA
5	GND	13	HSYNC
6	GND	14	VSYNC
7	GND	15	DDC LOCK
8	GND		

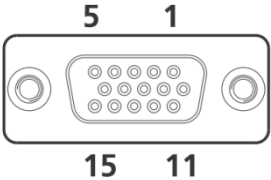

HDMI: HDMI

Pin	Definition	Pin	Definition
1	HDMI_2P	11	GND
2	GND	12	HDMI_CLKN
3	HDMI_2N	13	NC
4	HDMI_1P	14	NC
5	GND	15	DDC CLOCK
6	HDMI_1N	16	DDC DATA
7	HDMI_0P	17	GND
8	GND	18	+5V
9	HDMI_0N	19	HOTPLUG_DETECT
10	HDMI_CLKP		

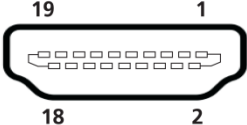

COM1: RS232/422/485 with +12V/+5V selection

Pin	RS-232	RS-422	Half Duplex RS-485
1	DCD-	TX-	DATA-
2	RXD	RX+	NA
3	TXD	TX+	DATA+
4	DTR-	RX-	NA
5	GND	GND	GND
6	DSR-	NA	NA
7	RTS-	NA	NA
8	CTS-	NA	NA
9	COM1P9SEL (Define by JP5)	COM1P9SEL (Define by JP5)	COM1P9SEL (Define by JP5)

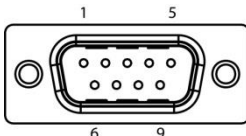

MINI_MPCIE: Mini PCIe connector

Pin	Definition	Pin	Definition
1	WAKE#	2	+3.3VAUX
3	NC	4	GND
5	NC	6	+1.5V
7	CLKREQ#	8	NC
9	GND	10	NC
11	REF CLK-	12	NC
13	REF CLK+	14	NC
15	GND	16	NC
17	NC	18	GND
19	NC	20	Wireless LAN Disable#
21	GND	22	RESET#
23	RXN	24	+3.3VAUX
25	RXP	26	GND
27	GND	28	+1.5V
29	GND	30	SMBUS CLOCK
31	TXN	32	SMBUS DATA
33	TXP	34	GND
35	GND	36	USB DATA-
37	GND	38	USB DATA+
39	+3.3VAUX	40	GND
41	+3.3VAUX	42	NC
43	GND	44	NC
45	Control Link CLOCK	46	NC
47	Control Link DATA	48	+1.5V
49	Control Link RESET#	50	GND
51	Blue Tooth Disable#	52	+3.3V VAUX

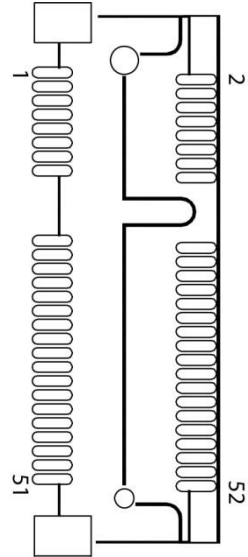

2.3 Internal Connectors

SATA1, SATA2: Serial ATA 3.0 Connector

Pin	Definition
1	GND
2	TXP
3	TXN
4	GND
5	RXN
6	RXP
7	GND

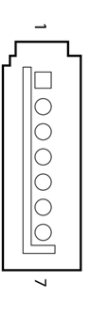

SATA3, SATA4: Serial ATA 2.0 Connector

Pin	Definition
1	GND
2	TXP
3	TXN
4	GND
5	RXN
6	RXP
7	GND

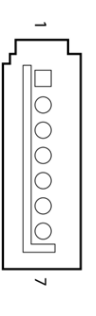

SATAPO, SATAP1: SATA Power Connector

Pin	Definition
1	+5V
2	GND
3	GND
4	+12V



PCI: PCI

Pin	Definition	Pin	Definition	Pin	Definition	Pin	Definition
A1	Pull down 4.7K to GND	A32	AD16	B1	-12V	B32	AD17
A2	+12V	A33	+3.3	B2	GND	B33	CBE2#
A3	GND	A34	FRAME#	B3	GND	B34	GND
A4	GND	A35	GND	B4	NC	B35	IRDY#
A5	+5V	A36	TRDY#	B5	+5V	B36	+3.3V
A6	INTA#	A37	GND	B6	+5V	B37	DEVSEL#
A7	INTC#	A38	STOP#	B7	INTB#	B38	GND
A8	+5V	A39	+3.3V	B8	INTD#	B39	LOCK#
A9	GNT1#	A40	SMBUS CLOCK	B9	NC	B40	PERR#
A10	+5V	A41	SMBUS DATA	B10	REQ1#	B41	+3.3V
A11	NC	A42	GND	B11	NC	B42	SERR#
A12	GND	A43	PAR	B12	GND	B43	+3.3V
A13	GND	A44	AD15	B13	GND	B44	CBE1#
A14	+3.3VAUX	A45	+3.3V	B14	CLOCK1	B45	AD14
A15	RESET#	A46	AD13	B15	GND	B46	GND
A16	+5V	A47	AD11	B16	CLOCK0	B47	AD12
A17	GNT0#	A48	GND	B17	GND	B48	AD10
A18	GND	A49	AD9	B18	REQ0#	B49	GND
A19	PCI PME#	A50	Keyway	B19	+5V	B50	Keyway
A20	AD30	A51	Keyway	B20	AD31	B51	Keyway
A21	+3.3V	A52	CBE0#	B21	AD29	B52	AD8
A22	AD28	A53	+3.3V	B22	GND	B53	AD7
A23	AD26	A54	AD6	B23	AD27	B54	+3.3V
A24	GND	A55	AD4	B24	AD25	B55	AD5
A25	AD24	A56	GND	B25	+3.3V	B56	AD3
A26	AD20	A57	AD2	B26	CBE3#	B57	GND
A27	+3.3V	A58	AD0	B27	AD23	B58	AD1
A28	AD22	A59	+5V	B28	GND	B59	+5V
A29	AD20	A60	REQ64#	B29	AD21	B60	ACK64#
A30	GND17	A61	+5V	B30	AD19	B61	+5V
A31	AD18	A62	+5V	B31	+3.3V	B62	+5V

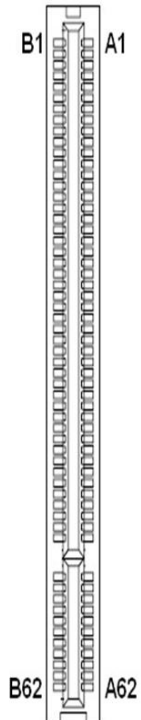

Chapter 3: System Setup

This chapter provides more detailed information and let you know how to install components into the ROC235A embedded System.



Prior to removing the chassis cover, make sure the unit's power is off and disconnected from the power sources to prevent electric shock or system damage.

3.1 2.5" SATA HDD/SSD installation

ROC235A supports 2 x 2.5" SATA HDD/SSD

1. Drive five screws off for remove the upper case from chassis.



2. Remove 4 screws from the screw hole to take off the HDD bracket.

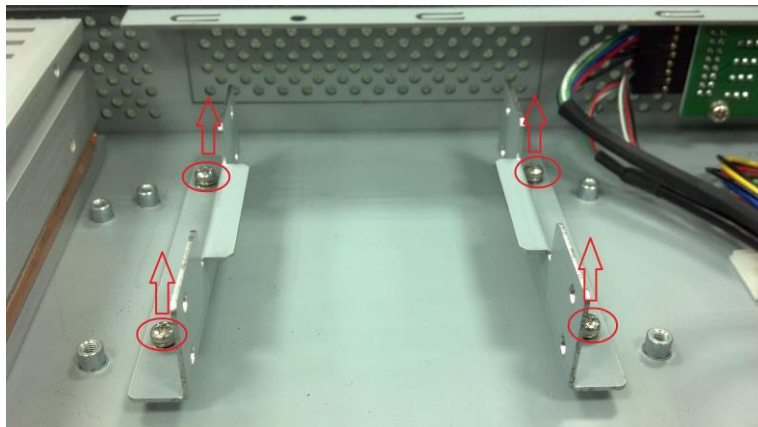

3. Insert left and right side 4 screws to firm the 2.5" HDD. Using accessory item P/N: OF0102500400000L



4. Insert each of left and right side screws, to set 2.5" HDD into system.



3.2 CPU installation

ROC235A supports Intel® 22nm Ivy Bridge Processor (Mobile) socket (rPGA988)

Core™ i7-3610QE (4C x 3.3 GHZ), 6M L2 cache (45W)

Core™ i5-3610ME (2C x 2.7 GHZ), 3M L2 cache (35W)

Core™ i3-3120ME (2C x 2.4 GHZ), 3M L2 cache (35W)

1. Remove 4 screws from CPU heat sink's cover, and 4 screws of left bracket from system heat sink.

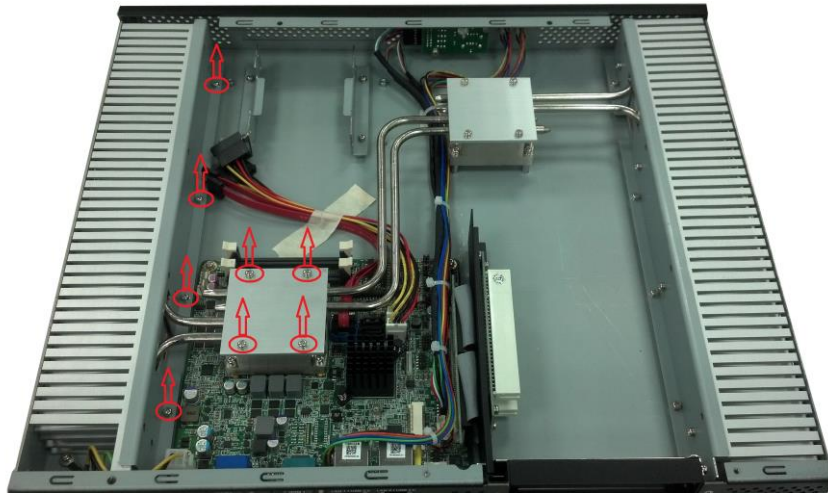

2. Take off the CPU heat sink's cover.



3. Pull out the heatsink on the left side.

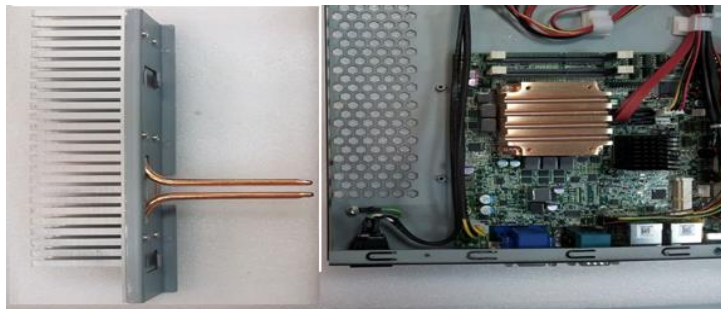

4. Unscrew two of screws on system heat sink, and pull the heat pipe up from CPU heat sink. Drive 4 screws off to remove CPU heat sink.

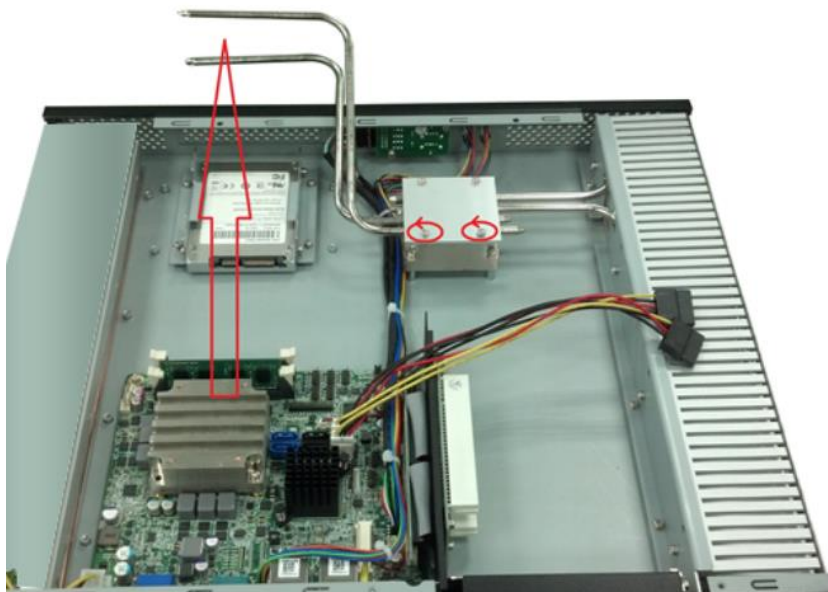

5. After pick up CPU heat sink you can set CPU on CPU socket.



- Put the thermal pad (P/N: 0R0100250160000L) on the CPU, screw the system heatsink back, put the heat sink with heatpipe back on the left side, screw the heatsink's cover back, then fasten 4 screws of left bracket from system heat sink.

thermal pad



3.3 Memory module installation

ROC235A supports 2 x 204-pin SO-DIMM DDR3 1333/1600 MHz up to 16GB

- Remove the top case and locate 2 memory slots on the motherboard.
- Insert the RAM into the RAM slot. Align the notch on the module with the notch in the slot, and then apply equal pressure onto the stick until the clamps on the side click and lock the RAM in. You may have to apply a fair amount of pressure, but never force it in.

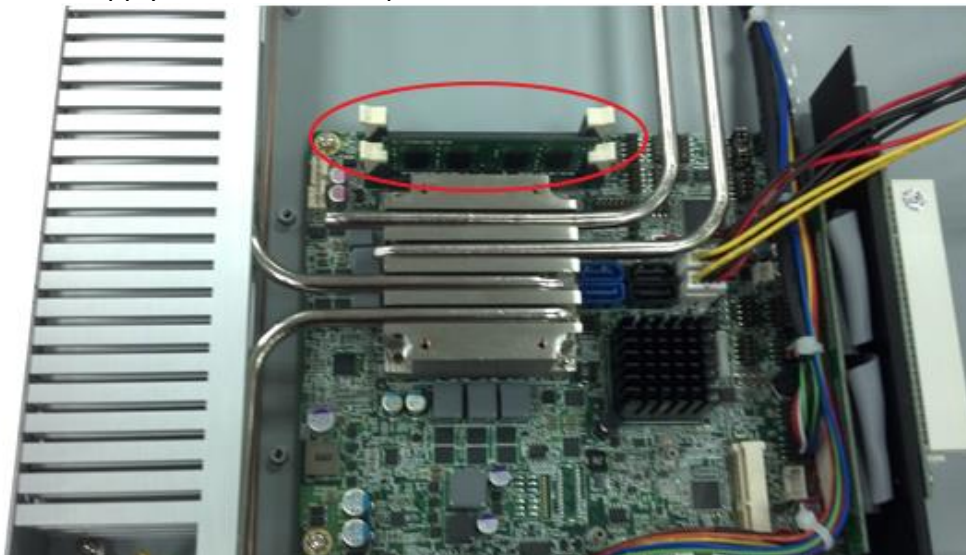

3.4 PCI riser card installation

ROC235A supports 2 x PCI expansion slots.

1. Drive each 5 screws off as the marks for remove riser card.

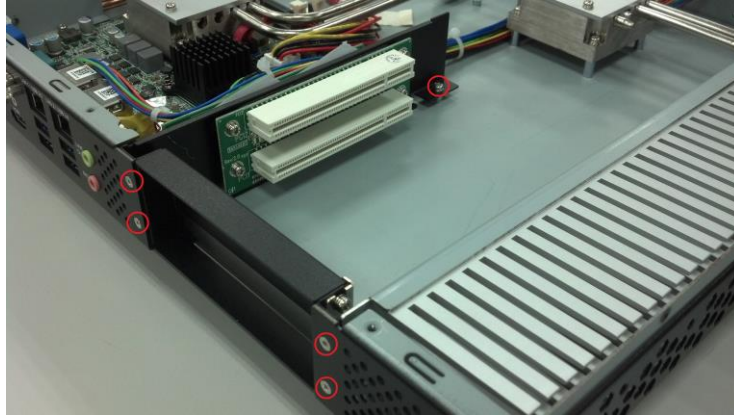

2. Remove the screws to set PCI add-on card on PCI riser card.



3. Insert PCI add-on card into PCI slot from riser card.



4. Insert add-on card screw to firm the add-on card, and insert the PCI riser's bridge board to motherboard PCI slot.

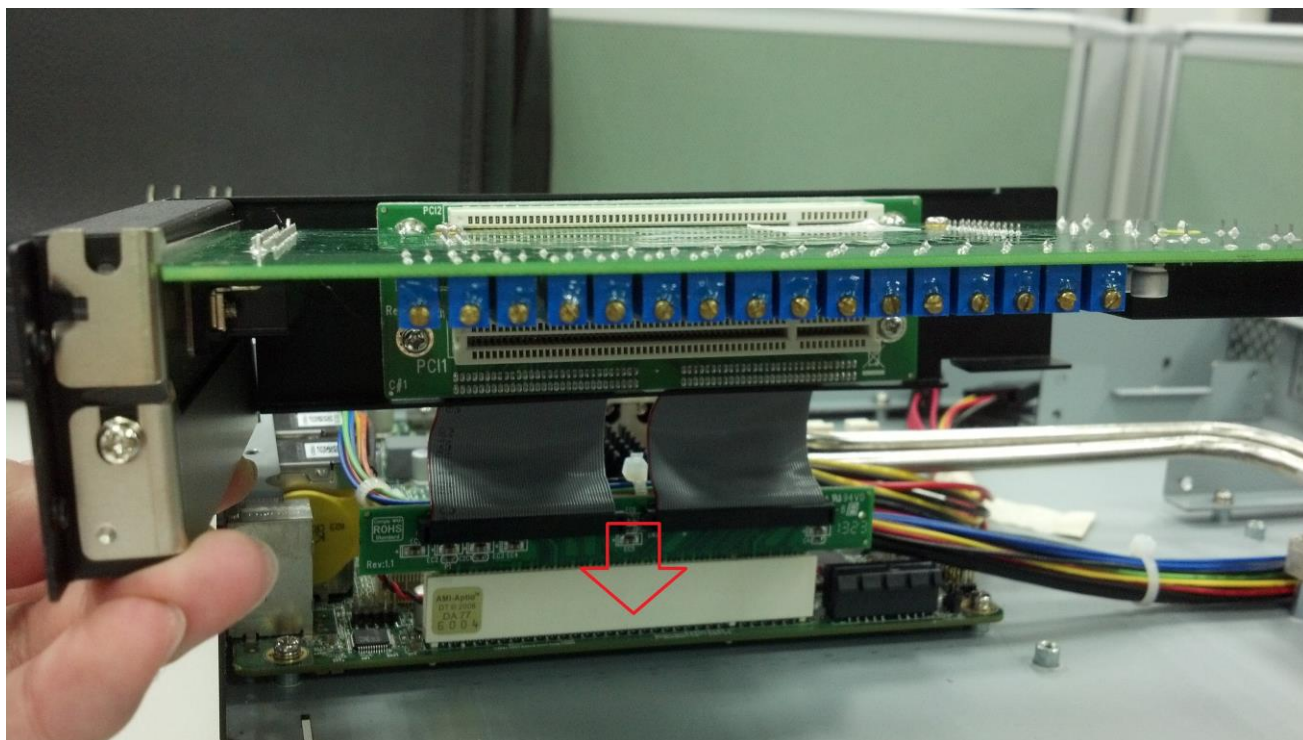

5. Insert PCI riser back to system and lock each screws.

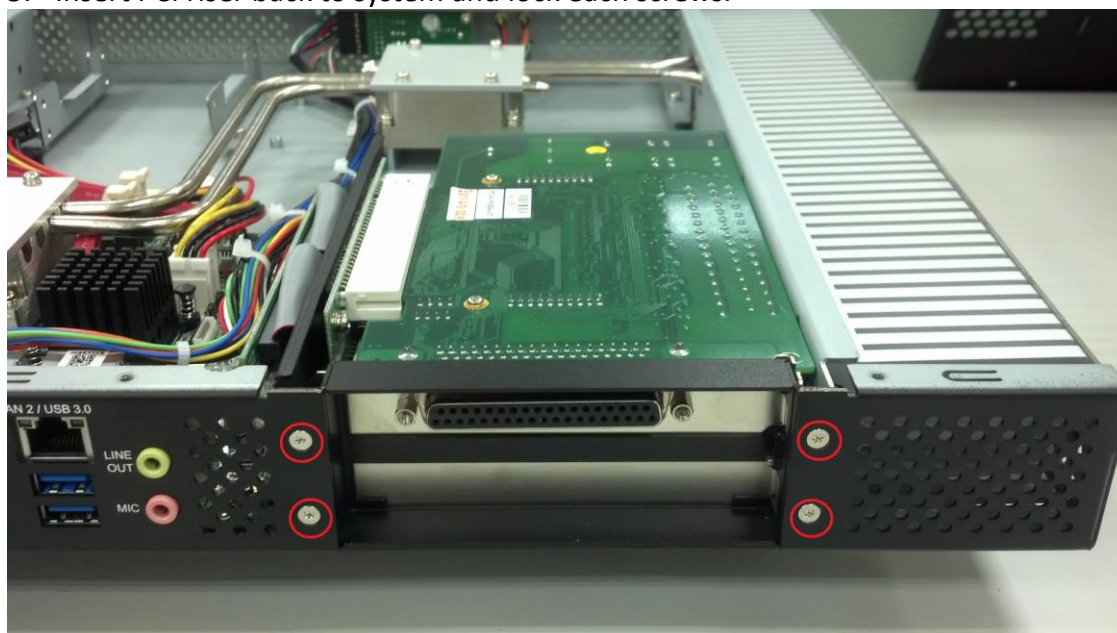

3.5 Rack mount bracket installation

For install rack mount bracket, insert each screws (P/N: 0F0130600600000L and 0F0132700800000L) as red spot screw holes to firm the bracket.



Chapter 4: AMI BIOS UTILITY

This chapter provides users with detailed descriptions on how to set up a basic system configuration through the AMI BIOS setup utility.

4.1 Starting

To enter the setup screens, perform the following steps:

- Turn on the computer and press the key immediately.
- After the key is pressed, the main BIOS setup menu displays. Other setup screens can be accessed from the main BIOS setup menu, such as the Chipset and Power menus.

4.2 Navigation Keys

The BIOS setup/utility uses a key-based navigation system called hot keys. Most of the BIOS setup utility hot keys can be used at any time during the setup navigation process.

Some of the hot keys are <F1>, <F10>, <Enter>, <ESC>, and <Arrow> keys.



Some of the navigation keys may differ from one screen to another.

Left/Right	The Left and Right <Arrow> keys moves the cursor to select a menu.
Up/Down	The Up and Down <Arrow> keys moves the cursor to select a setup screen or sub-screen.
+– Plus/Minus	The Plus and Minus <Arrow> keys changes the field value of a particular setup setting.
Tab	The <Tab> key selects the setup fields.
F1	The <F1> key displays the General Help screen.
F10	The <F10> key saves any changes made and exits the BIOS setup utility.
Esc	The <Esc> key discards any changes made and exits the BIOS setup utility.
Enter	The <Enter> key displays a sub-screen or changes a selected or highlighted option in each menu.

4.3 Main Menu

The Main menu is the first screen that you will see when you enter the BIOS Setup Utility.

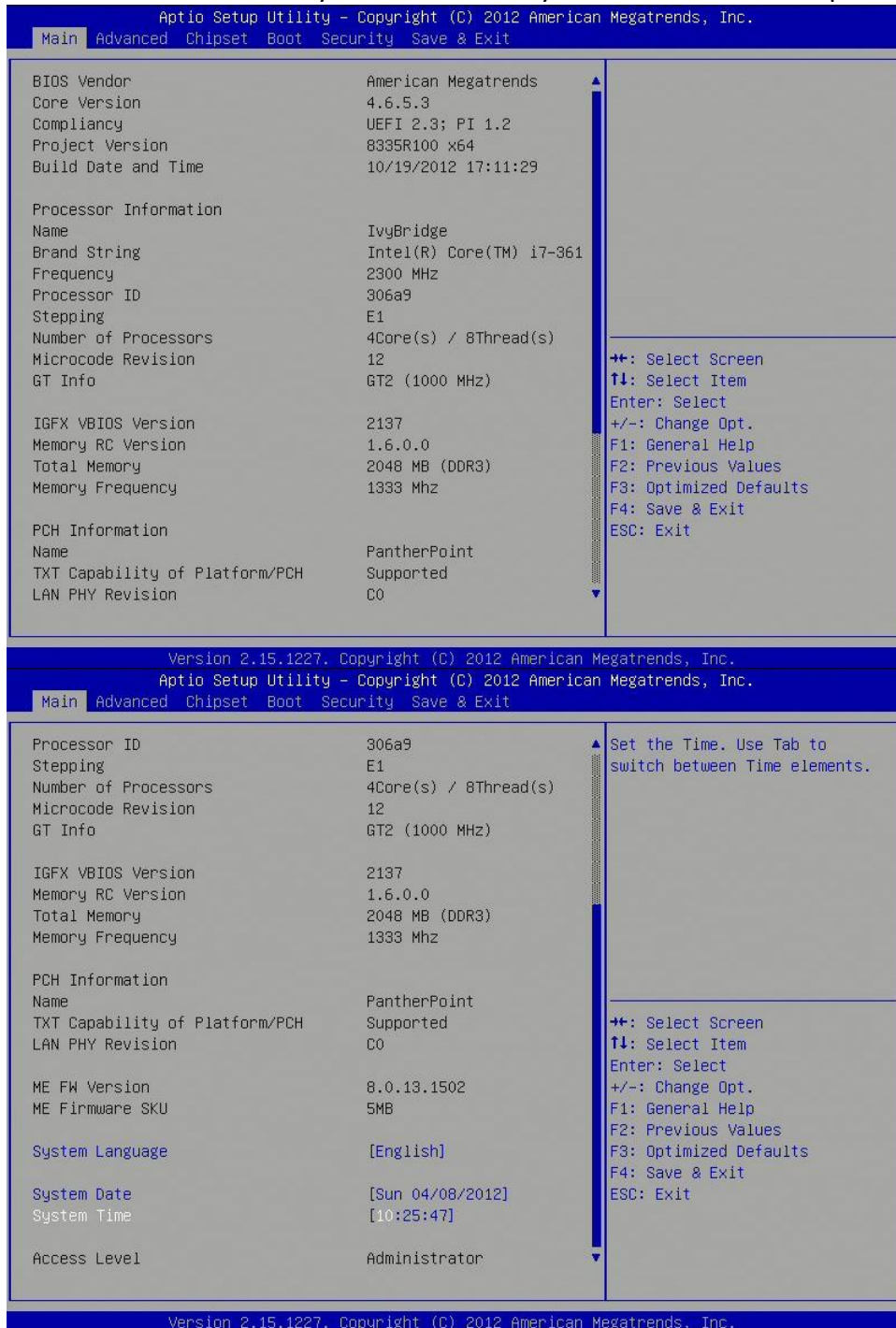

System Language

Use this function to select the system language.

System Date

Use this function to change the system date.

Select System Date using the Up and Down <Arrow> keys. Enter the new values through the keyboard. Press the Left and Right <Arrow> keys to move between fields.

The date setting must be entered in MM/DD/YY format.

System Time

Use this function to change the system time.

Select System Time using the Up and Down <Arrow> keys. Enter the new values through the keyboard. Press the Left and Right <Arrow> keys to move between fields.

The time setting is entered in HH:MM:SS format.

Note: The time is in 24-hour format. For example, 5:30 A.M. appears as 05:30:00, and 5:30 P.M. as 17:30:00.

Access Level

Displays the access level of the current user in the BIOS.

4.4 Advanced Menu

The Advanced Menu allows you to configure your system for basic operation. Some entries are defaults required by the system board, while others, if enabled, will improve the performance of your system or let you set some features according to your preference. **Setting incorrect field values may cause the system to malfunction.**

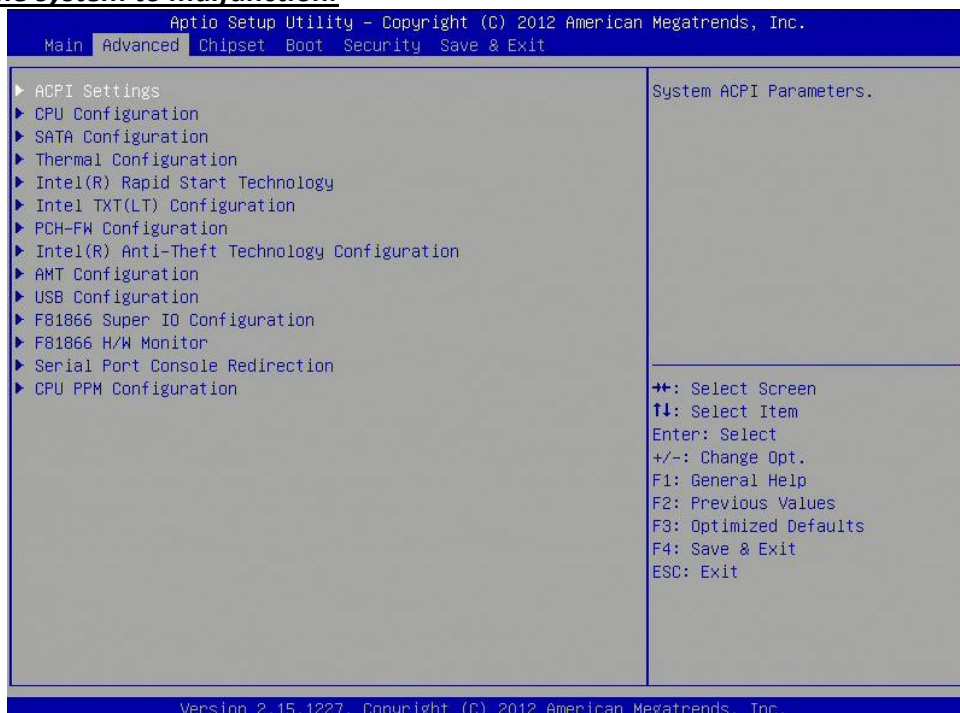

4.4.1 ACPI Settings

System ACPI parameters

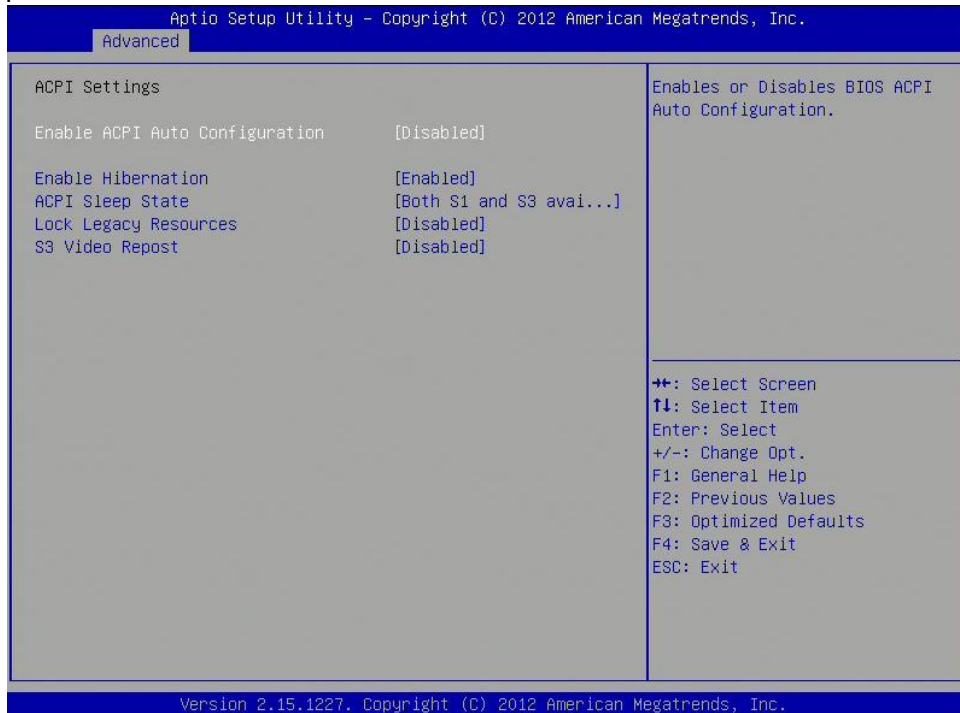

Enable ACPI Auto Configuration

Enables or disables BIOS ACPI auto configuration.

Enable Hibernation

Enables or disables system ability to hibernate (OS/S4 Sleep State). This option may not be effective with some OS.

ACPI Sleep State

Select the ACPI sleep state the system will enter when the suspend button is pressed.

Lock Legacy Resources

Enables or Disables System Lock of Legacy Resources.

S3 Video Repost

Enable or disable S3 Video Repost.

4.4.2 CPU Configuration

This section is used to configure the CPU.

Aptio Setup Utility - Copyright (C) 2012 American Megatrends, Inc.

Advanced

CPU Configuration		Enabled for Windows XP and Linux (OS optimized for Hyper-Threading Technology) and Disabled for other OS (OS not optimized for Hyper-Threading Technology). When Disabled only one thread per enabled core is enabled.
Intel(R) Core(TM) i7-3610QE CPU @ 2.30GHz		
CPU Signature	306a9	↑: Select Screen ↓: Select Item Enter: Select +/-: Change Opt. F1: General Help F2: Previous Values F3: Optimized Defaults F4: Save & Exit ESC: Exit
Microcode Patch	12	
Max CPU Speed	2300 MHz	
Min CPU Speed	1200 MHz	
CPU Speed	2300 MHz	
Processor Cores	4	
Intel HT Technology	Supported	
Intel VT-x Technology	Supported	
Intel SMX Technology	Supported	
64-bit	Supported	
L1 Data Cache	32 KB x 4	
L1 Code Cache	32 KB x 4	
L2 Cache	256 KB x 4	
L3 Cache	6144 KB	
Hyper-threading	[Enabled]	
Active Processor Cores	[All]	
Limit CPUID Maximum	[Disabled]	
Execute Disable Bit	[Enabled]	
Intel Virtualization Technology	[Enabled]	
Hardware Prefetcher	[Enabled]	

Version 2.15.1227. Copyright (C) 2012 American Megatrends, Inc.

Aptio Setup Utility - Copyright (C) 2012 American Megatrends, Inc.

Advanced

Microcode Patch		The Maximum instantaneous current allow for Secondary Plane
Microcode Patch	12	
Max CPU Speed	2300 MHz	↑: Select Screen ↓: Select Item Enter: Select +/-: Change Opt. F1: General Help F2: Previous Values F3: Optimized Defaults F4: Save & Exit ESC: Exit
Min CPU Speed	1200 MHz	
CPU Speed	2300 MHz	
Processor Cores	4	
Intel HT Technology	Supported	
Intel VT-x Technology	Supported	
Intel SMX Technology	Supported	
64-bit	Supported	
L1 Data Cache	32 KB x 4	
L1 Code Cache	32 KB x 4	
L2 Cache	256 KB x 4	
L3 Cache	6144 KB	
Hyper-threading	[Enabled]	
Active Processor Cores	[All]	
Limit CPUID Maximum	[Disabled]	
Execute Disable Bit	[Enabled]	
Intel Virtualization Technology	[Enabled]	
Hardware Prefetcher	[Enabled]	
Adjacent Cache Line Prefetch	[Enabled]	
TCC Activation offset	10	
Primary Plane Current value	0	
Secondary Plane Current value	0	

Version 2.15.1227. Copyright (C) 2012 American Megatrends, Inc.

Hyper-threading

Enabled for Windows XP and Linux (OS optimized for Hyper-Threading Technology) and Disabled for other OS (OS not optimized for Hyper-Threading Technology). When disabled only one thread per enabled core is enabled.

Active Processor Cores

Number of cores to enable in each processor package.

Limit CPUID Maximum

Disabled for Windows XP.

Execute Disable Bit

XD can prevent certain classes of malicious buffer overflow attacks when combined with a supporting OS (Windows Sever 2003 SP1, Windows XP SP2, SuSE Linux 9.2, RedHat Enterprise 3 Update 3.)

Intel Virtualization Technology

When enabled, a VMM can utilize the additional hardware capabilities provided by Vanderpool Technology.

Hardware Prefetcher

To turn on/off the Mid Level Cache (L2) streamer prefetcher

Adjacent Cache Line Prefetcher

To turn on/off prefetching of adjacent cache lines

TCC Activation Offset

Offset from the factory TCC activation temperature

Primary Plane Current Value

The Maximum instantaneous current allow for primary plane

Secondary Plane Current Value

The Maximum instantaneous current allow for secondary plane

4.4.3 SATA Configuration

This section is used to configure the SATA drives.

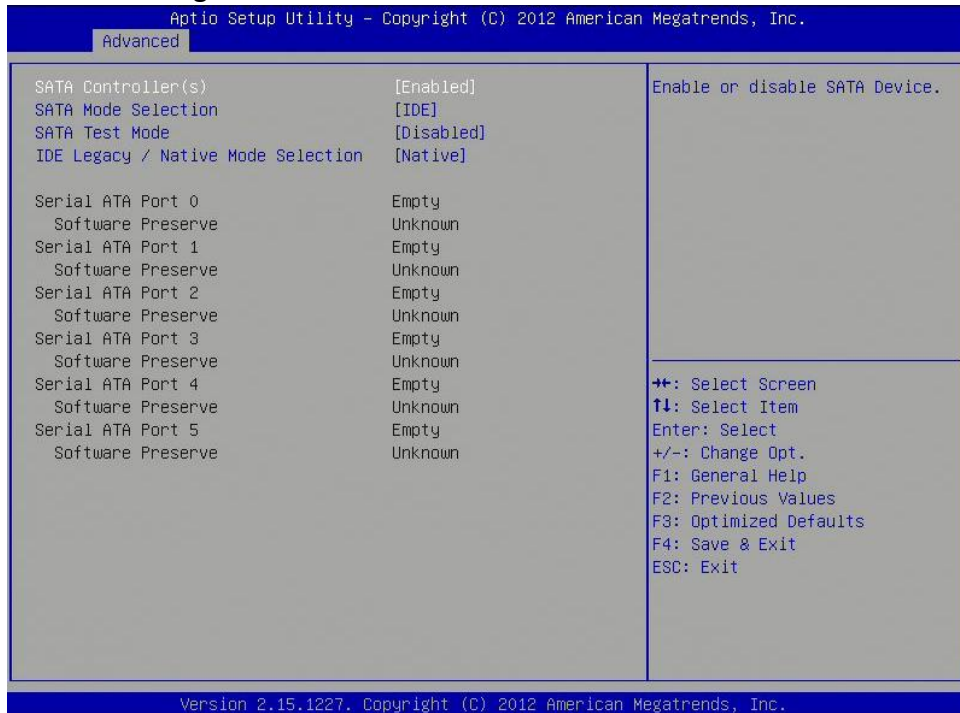

SATA Controller(s)

Enable or disable SATA device.

SATA Mode Selection

Determines how SATA controller(s) operate.

SATA Test Selection

Enable or disable Test Mode

IDE Legacy/Native Mode Selection

IDE Legacy/Native Mode Selection

Serial ATA Port 0 – 5

Displays information on the SATA devices detected

4.4.4 Thermal Configuration

Platform thermal configuration options



4.4.4.1 Platform thermal configuration



4.4.5 Intel Rapid Start Technology

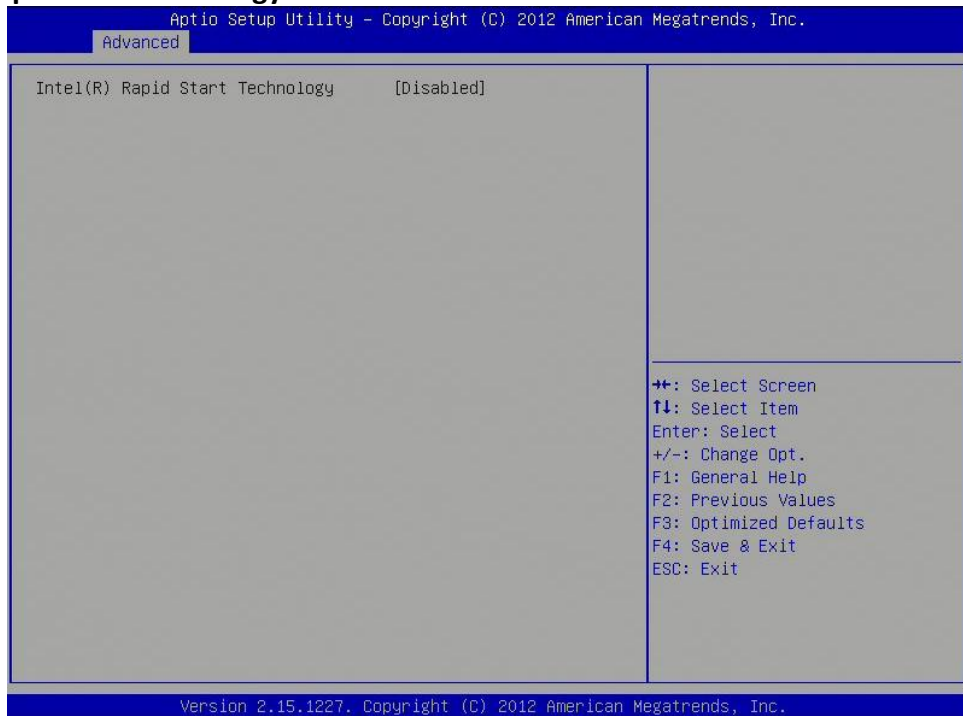

4.4.6 Intel TXT(LT) Configuration

Intel Trusted Execution Technology



Intel TXT(LT) Support

Enables or disables Intel TXT(LT) support

4.4.7 PCH-FW Configuration

This section is used to configure Management Engine Technology parameters.

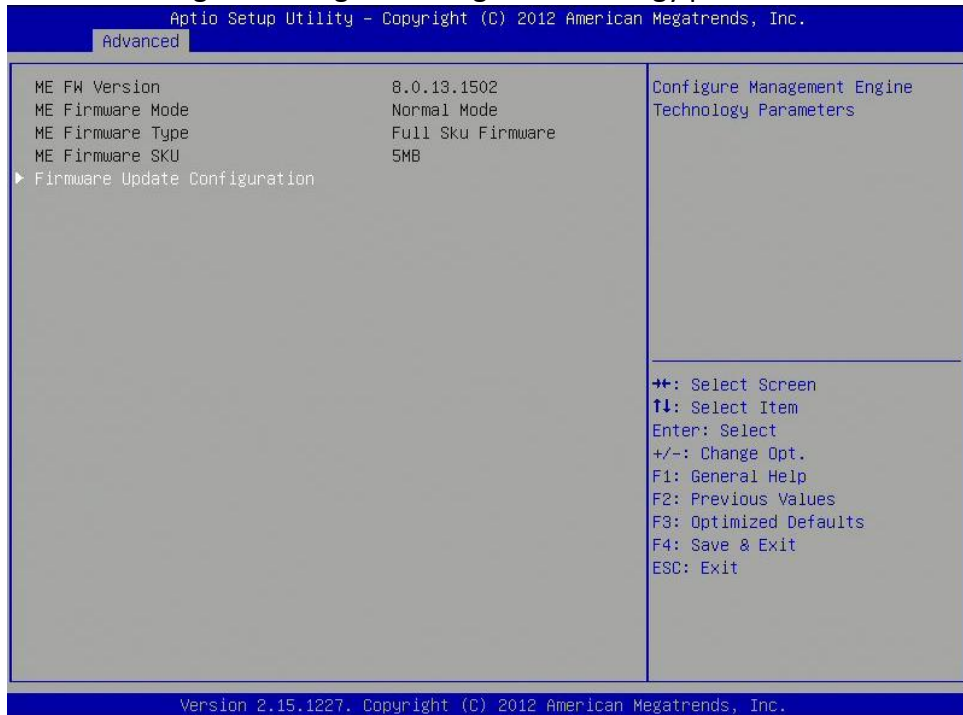

4.4.8 Intel Anti-Theft Technology Configuration

Disabling Intel AT allow user to login platform. This is strictly for testing only. This does not disable Intel AT services in ME



Intel Anti-Theft Technology

Enable or Disable Intel AT in BIOS for testing only

Intel Anti-Theft Technology Rec

Set the number of times Recovery attempted will be allowed.

4.4.9 AMT Configuration

This section is used to configure Active Management Technology (AMT) options.

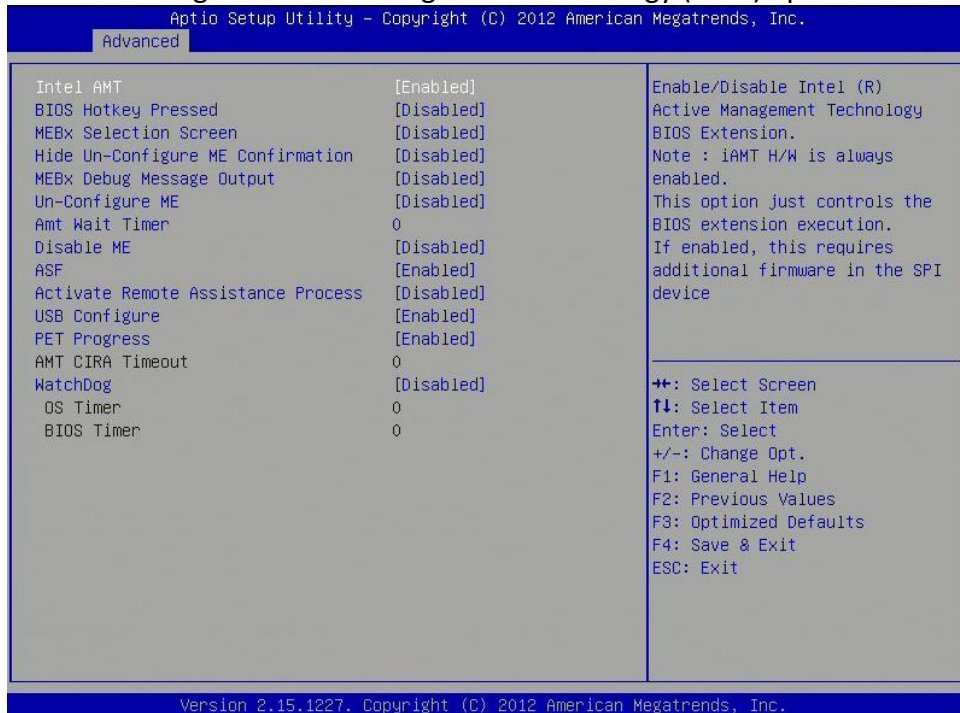

Intel AMT

Enable/disable Intel Active Management Technology BIOS extension.

Note: iAMT H/W is always enabled.

This option just controls the BIOS extension execution. If enabled, this requires additional firmware in the SPI device.

BIOS Hotkey Pressed

Enable/disable BIOS hotkey press.

MEBx Selection Screen

Enable/disable MEBx Selection Screen

Hide Un-Configure ME Confirmation

Hide Un-Configure ME without password confirmation prompt

MEBx Debug Message Screen

Enable MEBx debug message output

Un-Configure ME

Perform AMT/ME unconfigure without password operation.

Amt Wait Timer

Set timer to wait before sending ASF_GET_BOOT_OPTIONS.

Disable ME

Set ME to Soft Temporary Disabled

ASF

Enable/Disable Alert specification Format

Activate Remote Assistance Process

Trigger CIRA boot.

USB Configure

Enable/Disable USB configure function.

PET Progress

User can Enable/Disable PET Events progress to receive PET events or not.

Watchdog Timer

Enable/Disable Watchdog Timer.

4.4.10 USB Configuration

This section is used to configure the USB

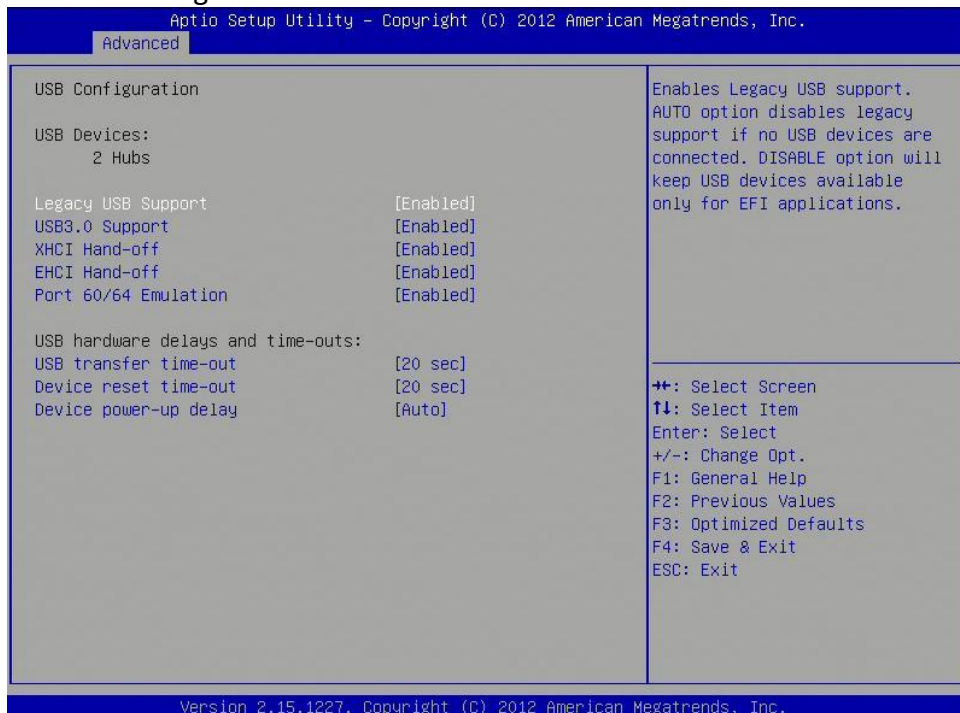

Legacy USB Support

Enables Legacy USB support.

AUTO option disables legacy support if no USB devices are connected.

DISABLE option will keep USB devices available only for EFI applications.

USB3.0 Support

Enable/Disable USB3.0 (XHCI) Controller support.

XHCI Hand-off

This is a workaround for OSes without XHCI hand-off support. The XHCI ownership change should be claimed by XHCI driver.

EHCI Hand-off

This is a workaround for OSes without EHCI hand-off support. The EHCI ownership change should be claimed by EHCI driver.

Port 64/60 Emulation

Enables I/O port 60h/64h emulation support. This should be enabled for the complete USB keyboard legacy support for non-USB aware OSes.

USB Transfer time-out

The time-out value for Control, Bulk, and Interrupt transfers.

Device reset time-out

USB mass Storage device start Unit command time-out.

Device power-up delay

Maximum time the device will take before it properly reports itself to the Host Controller. 'Auto' uses default value: for a Root port it is 100ms, for a Hub port the delay is taken from Hub descriptor.

4.4.11 F81866 Super IO Configuration

System super IO chip parameters

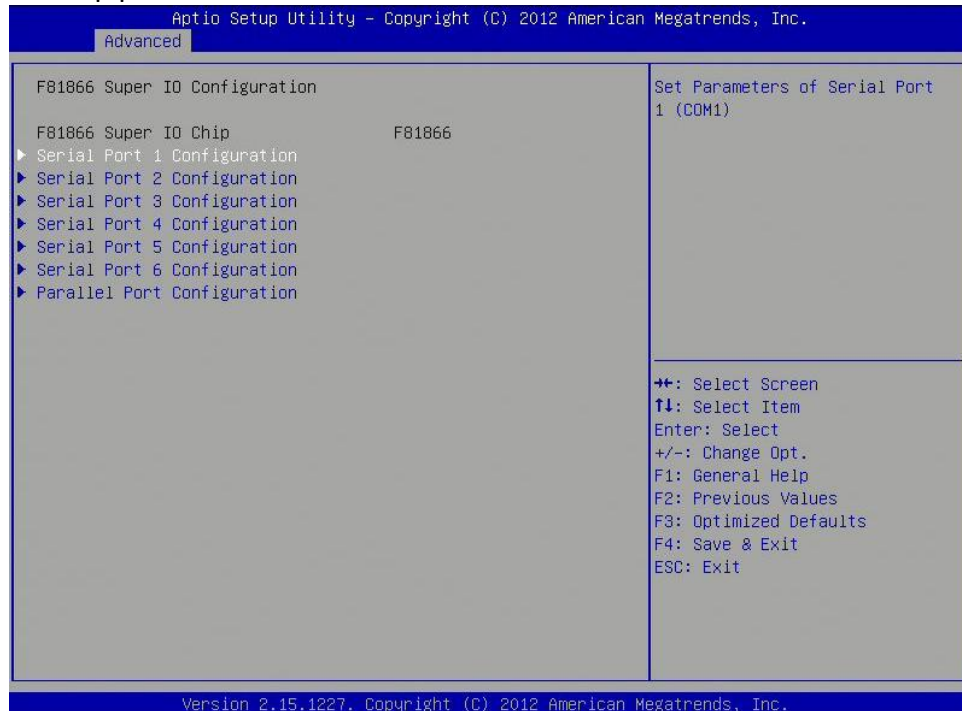

Serial Port Configuration

Set Parameters of Serial Ports. User can Enable/Disable the serial port and Select an optimal settings for the Super IO Device.

Parallel Port configuration

Set parameters of parallel port (LPT/LPTE)

4.4.12 F81866 H/W Monitor

This section is used to monitor hardware status such as temperature, fan speed and voltages.

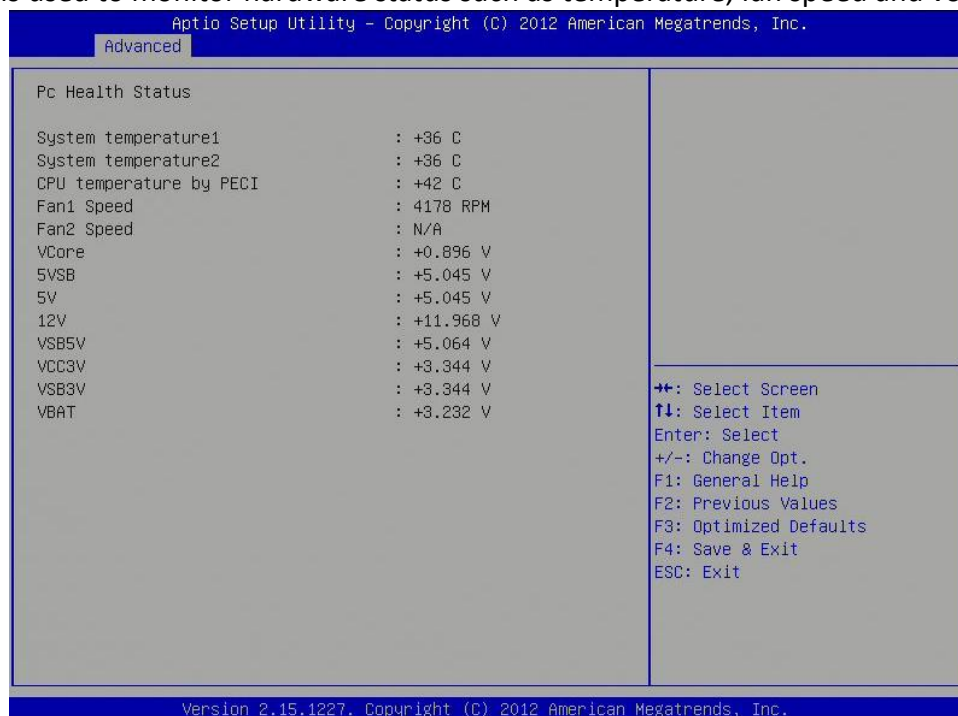

System Temperature

Detects and displays the current system temperature.

CPU Temperature

Detects and displays the current CPU temperature.

Fan1/2 Speed

Detects and displays the current CPU fan speed.

4.4.13 Serial Port Console Redirection

This screen provides information about functions for specifying the Serial Port Console Redirection configuration settings. Console redirection can be used to remotely operate system settings and the EFI console.

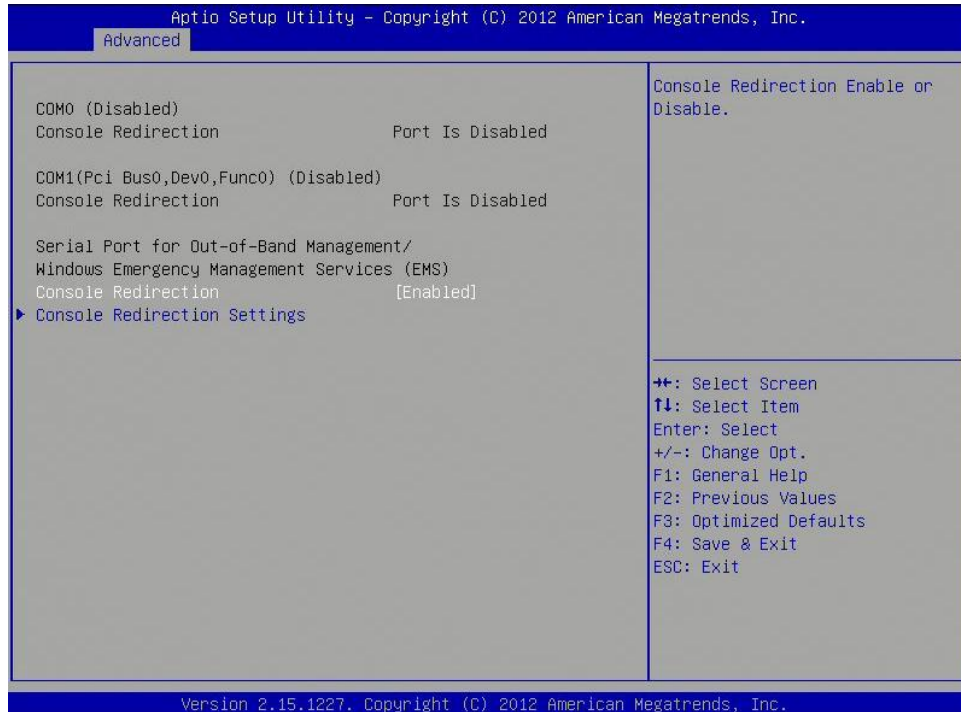

Console Redirection

Console Redirection Enable or Disable.

Console Redirection Settings

The setting specify how the host computer and the remote computer (which the user is using) will exchange data. Both computers should have the same or compatible settings.

4.4.14 CPU PPM Configuration

CPU PPM configuration parameters



EIST

Enables or disables Intel SpeedStep.

CPU C3 Report

Enable or disable CPU C3 (ACPI C2) report to OS.

Config TDP LOCK

Lock the Config TDP control register

Long duration power limit

Long duration power limit in Watts, 0 means use factory default.

Long duration maintained

Time window which the long duration power is maintained.

Short duration power limit

Short duration power limit in Watts, 0 means use factory default.

ACPI T State

Enable or disable ACPI state support.

4.5 Chipset

This section gives you functions to configure the system based on the specific features of the chipset. The chipset manages bus speeds and access to system memory resources.



4.5.1 PCH-IO Configuration

This section allows you to configure the North Bridge Chipset.



USB Configuration

USB configuration settings

PCH Azalia Configuration

PCH Azalia configuration settings

PCH LAN Controller

Enable or disable onboard NIC.

Wake on LAN

Enable or disable integrated LAN to wake the system. (The Wake On LAN cannot be disabled if ME is on at Sx state.)

PCIE LAN Controller

Enable or disable onboard PCIE LAN

Wireless LAN Controller

Enable or disable onboard MPCIE LAN-Wireless LAN.

SLP_S4 Assertion Width

Select a minimum assertion width of the SLP_S4# signal.

Restore AC Power Loss

Select AC power state when power is re-applied after a power failure.

RI Wake Up

RI wake up function select.

Watch Dog Function select

Watch Dog function enabled or disabled.

4.5.1.1 USB Configuration



XHCI Pre-Boot Driver

Enable or disable XHCI Pre-Boot driver support.

XHCI Mode

Mode of operation of XHCI controller

HS Port #1/2/3/4 Switchable

Allows for HS port switching between xHCI and EHCI. If disabled, port is routed to EHCI. If HS port is routed to xHCI, the corresponding SS port is enabled.

xHCI Streams

Enable or disable xHCI Maximum Primary Stream Array Size.

EHCI1/2

Control the USAB EHCI (USB 2.0) functions. One EHCI controller must always be enabled.

USB Ports Per-Port Disable Control

Control each of the USB ports (0~13) disabling.

4.5.1.2 PCH Azalia Configuration

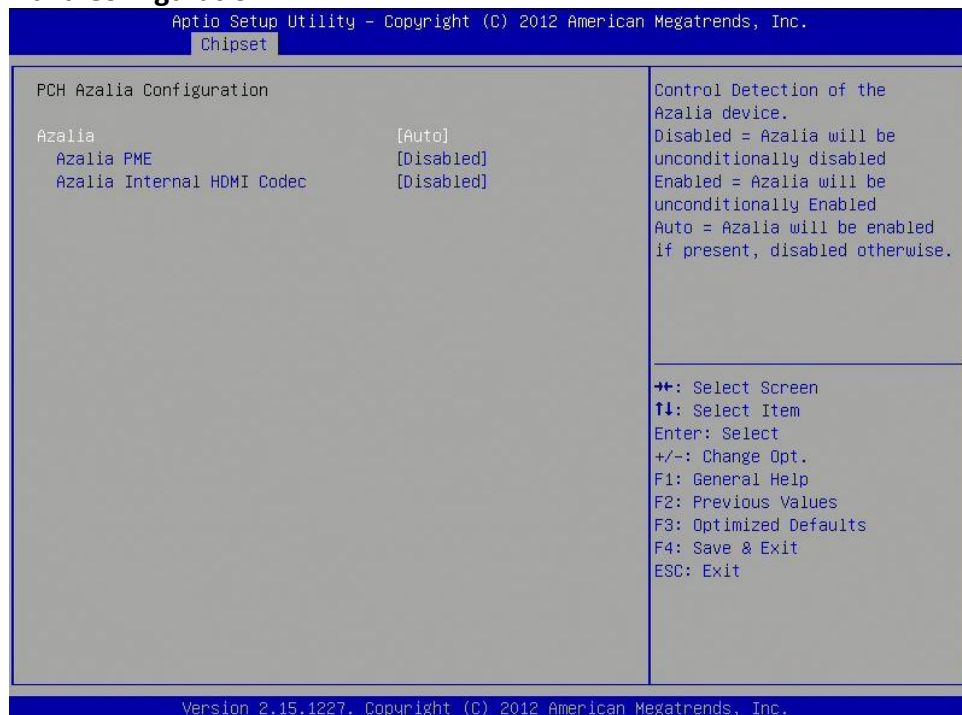

Azalia

Control Detection of the Azalia device.

Disabled=Azalia will unconditionally disabled.

Enabled=Azalia will be unconditionally enabled.

Auto=Azalia will enabled if present, disabled otherwise.

Azalia PME

Enable or disable Power Management capability of audio controller.

Azalia Internal HDMI codec

Enable or disable internal HDMI codec for Azalia.

4.5.2 System Agent (SA) Configuration

This section is used to configure the System Agent (SA) configuration.

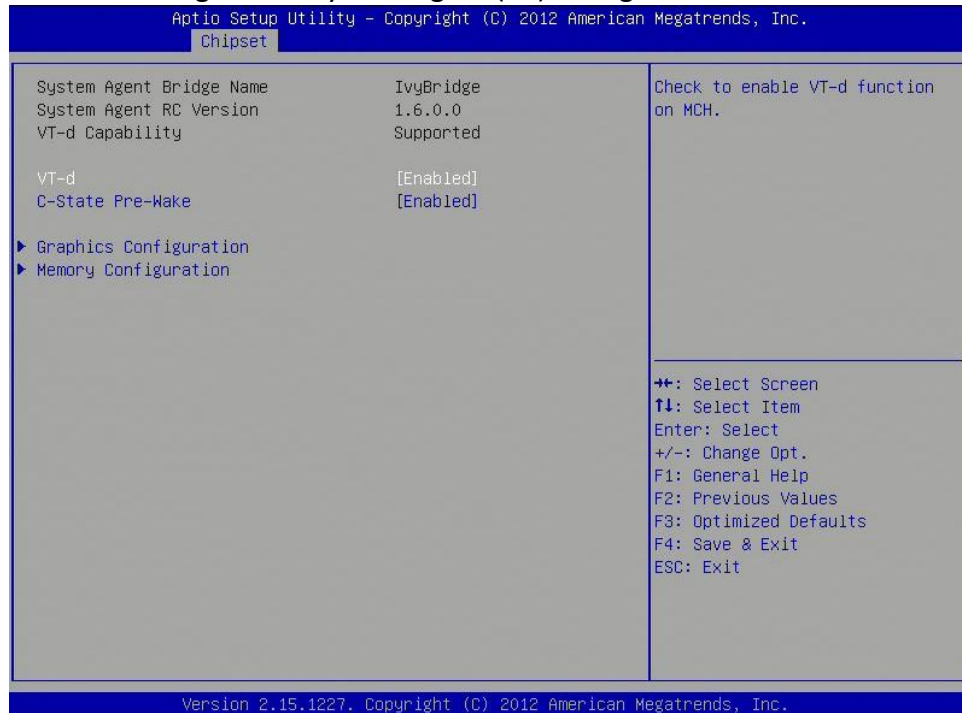

VT-d

Check to enable VT-d function on MCH.

Enable NB CRID

Enable or disable NB CRID WorkAround.

C-State Pre-Wake

Controls C-State Pre-Wake feature for ARAT, in SSKPD[57].

Graphics Configuration

Configure graphics settings

Memory Configuration

Memory configuration parameters

4.5.2.1 Graphics Configuration

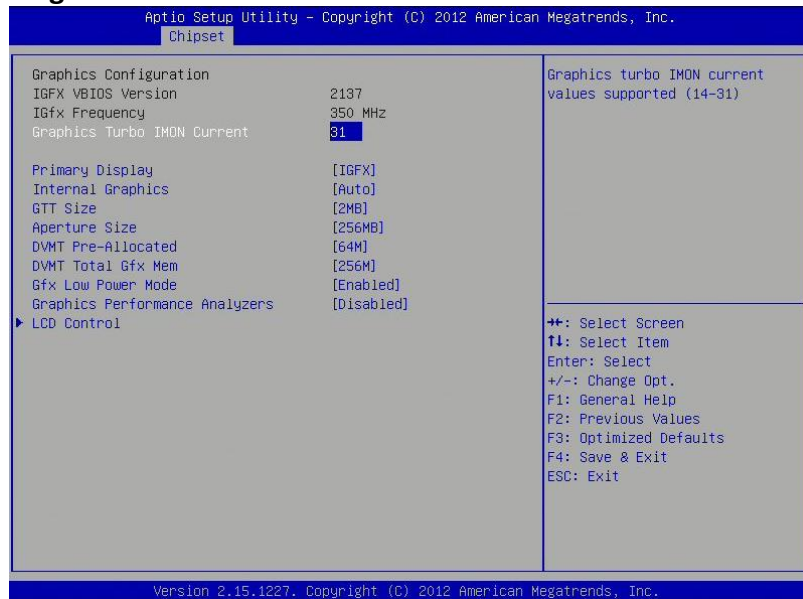

Primary Display

Select which of IGFX/PEG/PCI graphics device should be primary display or select SG for switchable Gfx.

Internal Graphics

Keep IGD enabled based on the setup options.

DVMT Pre-Allocated

Select DVMT 5.0 Pre-Allocated (Fixed) graphics memory size used by the internal graphics device.

DVMT Total Gfx Mem

Select DVMT 5.0 total graphics memory size used by the internal graphics device.

Gfx Low Power Mode

This option is applicable for SFF only.

Graphics Performance Analyzers

Enable or disable Intel graphics performance analyzers counters.

4.5.2.2 Memory Configuration

Apdio Setup Utility - Copyright (C) 2012 American Megatrends, Inc.
Chipset

<p>Memory Information</p> <p>Memory RC Version 1.6.0.0 Memory Frequency 1333 Mhz Total Memory 2048 MB (DDR3) DIMM#0 2048 MB (DDR3) DIMM#1 Not Present CAS Latency (tCL) 9 Minimum delay time CAS to RAS (trCDmin) 9 Row Precharge (trPmin) 9 Active to Precharge (tRASmin) 24 XMP Profile 1 Not Supported XMP Profile 2 Not Supported</p> <p>DIMM profile [Default DIMM profile] Memory Frequency Limiter [Auto] Max TOLUD [Dynamic] NMode Support [Auto] Memory Scrambler [Enabled] MRC Fast Boot [Enabled] Force Cold Reset [Enabled] DIMM Exit Mode [Fast Exit] Power Down Mode [PPD] Scrambler Seed Generation Off [Disabled]</p>	<p>▲ Select DIMM timing profile that should be used.</p> <hr/> <p>↔: Select Screen ↑↓: Select Item Enter: Select +/-: Change Opt. F1: General Help F2: Previous Values F3: Optimized Defaults F4: Save & Exit ESC: Exit</p>
---	---

Version 2.15.1227. Copyright (C) 2012 American Megatrends, Inc.
Apdio Setup Utility - Copyright (C) 2012 American Megatrends, Inc.
Chipset

<p>Total Memory 2048 MB (DDR3) DIMM#0 2048 MB (DDR3) DIMM#1 Not Present CAS Latency (tCL) 9 Minimum delay time CAS to RAS (trCDmin) 9 Row Precharge (trPmin) 9 Active to Precharge (tRASmin) 24 XMP Profile 1 Not Supported XMP Profile 2 Not Supported</p> <p>DIMM profile [Default DIMM profile] Memory Frequency Limiter [Auto] Max TOLUD [Dynamic] NMode Support [Auto] Memory Scrambler [Enabled] MRC Fast Boot [Enabled] Force Cold Reset [Enabled] DIMM Exit Mode [Fast Exit] Power Down Mode [PPD] Scrambler Seed Generation Off [Disabled] Memory Remap [Enabled] Memory Alias Check [Disabled] Channel A DIMM Control [Enable Both DIMMS] Channel B DIMM Control [Enable Both DIMMS]</p>	<p>▲ Enable or disable dimms on Channel B.</p> <hr/> <p>↔: Select Screen ↑↓: Select Item Enter: Select +/-: Change Opt. F1: General Help F2: Previous Values F3: Optimized Defaults F4: Save & Exit ESC: Exit</p>
--	---

Version 2.15.1227. Copyright (C) 2012 American Megatrends, Inc.

4.6 Boot Setting

This section is used to configure the boot features.

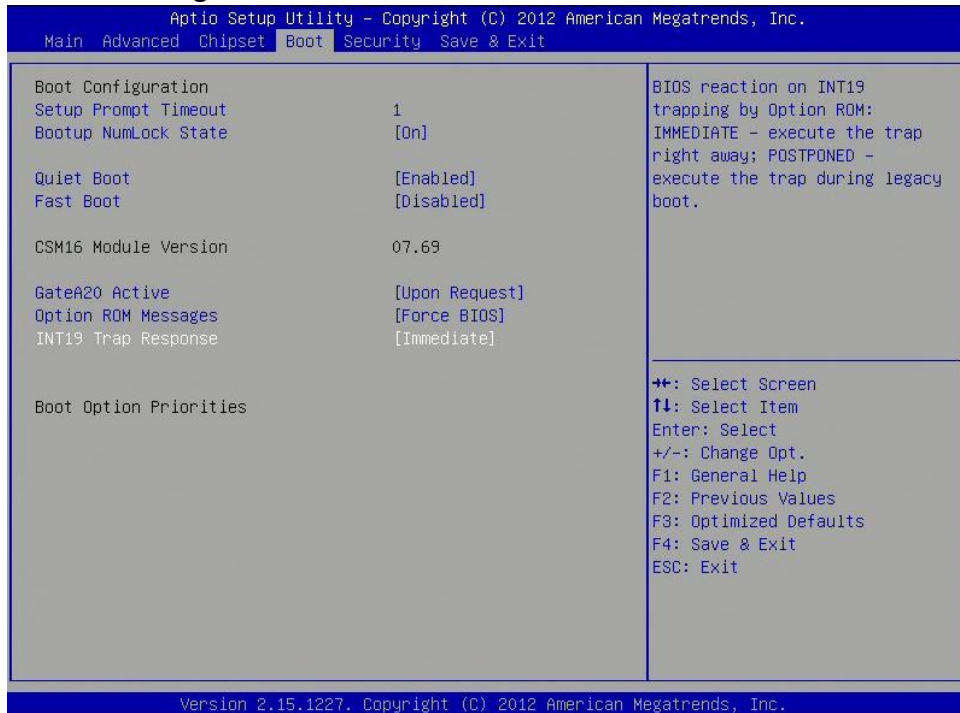

Setup Prompt Timeout

Number of seconds to wait for setup activation key. 65535(0xFFFF) means indefinite waiting.

Bootup NumLock State

Select the keyboard NumLock state.

Quiet Boot

Enables or Disables Quiet Boot option.

Fast Boot

Enables or Disables boot with initialization of a minimal set of devices required to launch active boot option. Has no effect for BBS boot options.

GateA20 Active

UPON REQUEST – GA20 can be disabled using BIOS services.

ALWAYS – do not allow disabling GA20; this option is useful when any RT code is executed above 1MB.

Option ROM Messages

Set display mode for Option ROM.

INT19 Trap Response

BIOS reaction on INT19 trapping by Option ROM: IMMEDIATE – execute the trap right away; POSTPONED – execute the trap during legacy boot.

Boot Option Priorities

Sets the system boot order.

4.7 Security

Use the Security Menu to establish system passwords

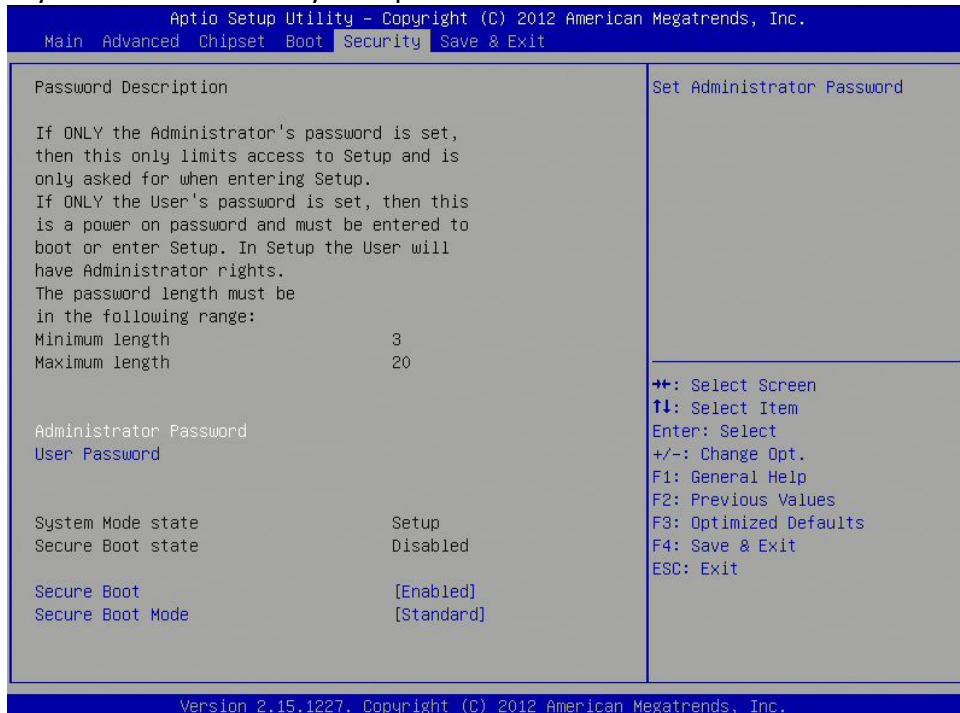

Administrator Password

Set administrator password.

User Password

Set User Password.

Secure Boot

Secure boot flow control. Secure boot is possible only if system runs in user mode.

Secure Boot Mode

Secure boot mode selector. 'Standard' – fixed secure boot policy, 'custom' – changeable image execution policy and secure boot key databases.

4.8 Save and exit

This screen provides functions for handling changes made to the BIOS settings and the exiting of the Setup program.

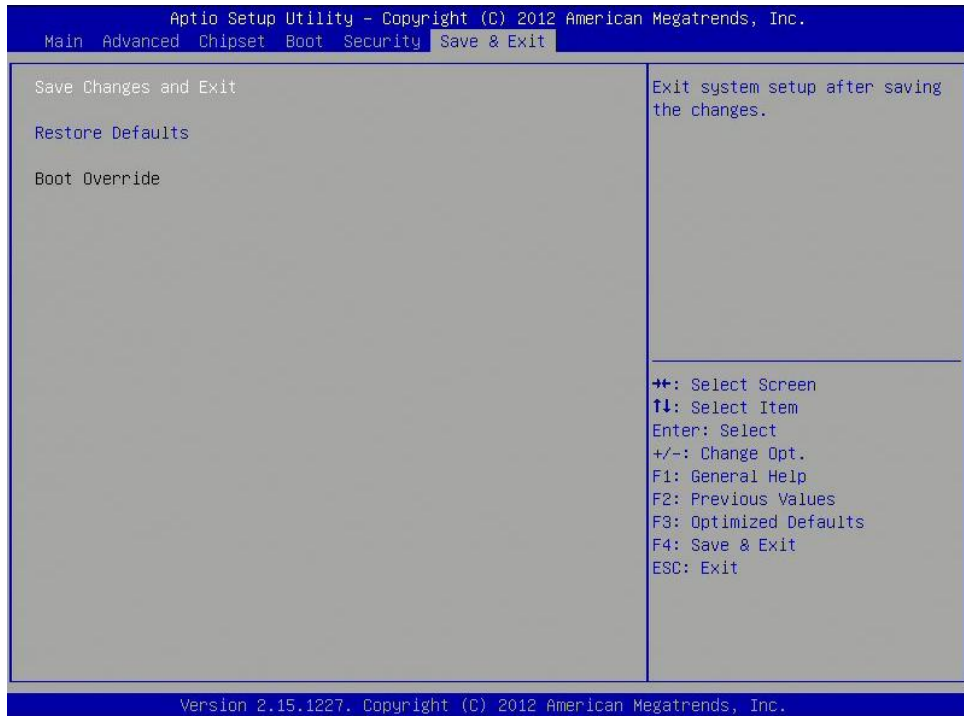

Save Changes and Exit

Exit system setup after saving the changes.

Restore Defaults

Restore or Load Defaults values for all the setup options.



7STARLAKE

ROC235A-ESK Manual

Michael

Safety information

Electrical safety

- To prevent electrical shock hazard, disconnect the power cable from the electrical outlet before relocating the system.
- When adding or removing devices to or from the system, ensure that the power cables for the devices are unplugged before the signal cables are connected. If possible, disconnect all power cables from the existing system before you add a device.
- Before connecting or removing signal cables from the motherboard, ensure that all power cables are unplugged.
- Seek professional assistance before using an adapter or extension cord. These devices could interrupt the grounding circuit.
- Make sure that your power supply is set to the correct voltage in your area.
- If you are not sure about the voltage of the electrical outlet you are using, contact your local power company.
- If the power supply is broken, do not try to fix it by yourself. Contact a qualified service technician or your local distributor.

Operation safety

- Before installing the motherboard and adding devices on it, carefully read all the manuals that came with the package.
- Before using the product, make sure all cables are correctly connected and the power cables are not damaged. If you detect any damage, contact your dealer immediately.
- To avoid short circuits, keep paper clips, screws, and staples away from connectors, slots, sockets and circuitry.
- Avoid dust, humidity, and temperature extremes. Do not place the product in any area where it may become wet.
- Place the product on a stable surface.
- If you encounter any technical problems with the product, contact your local distributor

Statement

- All rights reserved. No part of this publication may be reproduced in any form or by any means, without prior written permission from the publisher.
- All trademarks are the properties of the respective owners.
- All product specifications are subject to change without prior notice

Revision History

Revision	Date (yyyy/mm/dd)	Changes
V1.0	2014/7/15	Initial release
V1.1	2014/8/8	Update for system information
V1.2	2014/09/19	3. Change BRACKET EAR-2, BRACKET EAR-1 P/N 4. Add Screw Flower Flat Plating Ni White M3 L:4mm ø5.0*8pcs for screw the HDD/SSD (P/N: 0F0102500400000L)
V1.3	2015/09/08	Add memory module installation
V1.4	2017/04/25	Update I/O spec
V1.5	2023/07/25	Update Power module, DC-IN spec. EMI filter

Packing list

- 19" 1U Rack-mount Intel® QM77 Fanless Rugged System
 Accessories:

Item	P/N	Description	Q'ty
1	0P0600000003000L	Driver CD	1
2	0C1210122103100L	CONN DIP 1*3 P:5.0mm Pluggable terminal block Female	1
3	0R0100250160000L	Thermal pad GR-Hm 24.5x16.2mm T:0.3mm	1
4	0N0600000000000L	BRACKET EAR-L SPGC 280x43.4x21.3mm t:3mm	2
5	0N0600000000010L	BRACKET EAR-S SPGC 90x43.4x21.3mm t:3mm	2
6	0F0130600600000L	Screw cross circle Plating Ni White M4 L:6mm	10
7	0F0132700800000L	Screw Flat Plating Ni White M4 L:8mm	10
8	0F0102500400000L	Screw Flower Flat Plating Ni White M3 L:4mm	8



If any of the above items is damaged or missing, please contact your local distributor.

Ordering information

Model Number	Description
ROC235A-ET	Intel® QM77 Fanless Rugged System with Intel® Ivy Bridge Core™ i7/i5/i3 Processor, with 1xPCI & 1x PCIe Expansion, 9V to 24V DC-in, Wide Temp. (-20 to 70°C)
ROC235A-UT	Intel® QM77 Fanless Rugged System with Intel® Ivy Bridge Core™ i7/i5/i3 Processor, with 1xPCI & 1x PCIe Expansion, 9V to 24V DC-in, Wide Temp. (-40 to 70°C Optional)
ROC235A-ESK	Intel® QM77 Fanless Rugged System with Intel® Ivy Bridge Core™ i7/i5/i3 Processor, with 1xPCI & 1x PCIe Expansion, 13V to 35V DC-in, Wide Temp. (-20 to 70°C)
Processor	
Intel® Core™ i7-3610QE Processor (6M Cache, 2.30 GHz), 45 W	
Intel® Core™ i5-3610ME Processor (3M Cache, 2.70GHz), 35W	
Intel® Core™ i3-3120ME Processor (3M Cache, 2.40 GHz), 35W	

Table of Contents

SAFETY INFORMATION	1
ELECTRICAL SAFETY.....	1
OPERATION SAFETY.....	1
STATEMENT.....	1
REVISION HISTORY	2
PACKING LIST	2
ORDERING INFORMATION	2
TABLE OF CONTENTS	3
CHAPTER 1: PRODUCT INTRODUCTION	5
1.1 KEY FEATURES.....	5
1.2 FRONT PANEL COMPONENTS.....	6
1.3 REAR PANEL COMPONENTS.....	6
1.4 MECHANICAL DIMENSIONS.....	7
CHAPTER 2: JUMPERS AND CONNECTORS	8
2.1 FRONT PANEL CONNECTOR PIN DEFINITIONS.....	8
USB Port: USB2.0.....	8
Status Indicators.....	8
2.2 Rear Panel Connector Pin Definitions.....	9
LAN1_USB12: USB3.0 port 0,1 and LAN connector 1.....	9
LAN2_USB34: USB3.0 port 3,4 and LAN connector 2.....	9
AUDIO1: LINE-OUT/MIC-IN.....	9
DVI-D: DVI-D.....	9
VGA: VGA.....	10
HDMI: HDMI.....	10
COM1: RS232/422/485 with +12V/+5V selection.....	10
MINI_MPCIE: Mini PCIe connector.....	11
2.3 INTERNAL CONNECTORS.....	12
SATA1, SATA2: Serial ATA 3.0 Connector.....	12
SATA3, SATA4: Serial ATA 2.0 Connector.....	12
SATAP0, SATAP1: SATA Power Connector.....	12
PCI: PCI.....	13
CHAPTER 3: SYSTEM SETUP	14
3.1 2.5" 2.5" SATA SSD INSTALLATION.....	14
3.2 CPU INSTALLATION.....	16
3.3 MEMORY MODULE INSTALLATION.....	18
3.4 PCI RISER CARD INSTALLATION.....	19
3.5 RACK MOUNT BRACKET INSTALLATION.....	21
CHAPTER 4: AMI BIOS UTILITY	22
4.1 STARTING.....	22
4.2 NAVIGATION KEYS.....	222
4.3 MAIN MENU.....	233
4.4 ADVANCED MENU.....	24
4.4.1 ACPI Settings.....	255
4.4.2 CPU Configuration.....	266
4.4.3 SATA Configuration.....	28
4.4.4 Thermal Configuration.....	29
4.4.4.1 Platform thermal configuration.....	29

4.4.5 Intel Rapid Start Technology.....	30
4.4.6 Intel TXT(LT) Configuration	30
4.4.7 PCH-FW Configuration.....	31
4.4.8 Intel Anti-Theft Technology Configuration	31
4.4.9 AMT Configuration	32
4.4.10 USB Configuration	33
4.4.11 F81866 Super IO Configuration	35
4.4.12 F81866 H/W Monitor	36
4.4.13 Serial Port Console Redirection	37
4.4.14 CPU PPM Configuration.....	38
4.5 CHIPSET.....	39
4.5.1 PCH-IO Configuration	39
4.5.1.1 USB Configuration	41
4.5.1.2 PCH Azalia Configuration.....	42
4.5.2 System Agent (SA) Configuration.....	43
4.5.2.1 Graphics Configuration.....	44
4.5.2.2 Memory Configuration	45
4.6 BOOT SETTING.....	466
4.7 SECURITY.....	47
4.8 SAVE AND EXIT.....	47

Chapter 1: Product Introduction

1.1 Key Features

System	
CPU Type	Intel® 22nm Ivy Bridge Processor (Mobile) socket (rPGA988) Core™ i7-3610QE 2.3 GHz (6M Cache, 45W) Core™ i5-3610ME 2.7 GHz (3M Cache, 35W) Core™ i3-3120ME 2.4 GHz (3M Cache, 35W)
Chipset	Intel® QM77
Memory Type	2 x 204-pin SO-DIMM DDR3 1333/1600 MHz up to 16 GB
Expansion Slot	2 x PCI 1 x Mini PCIe
Storage Device	3 x 2.5" Swappable SSD Supports RAID 0,1
Front I/O	
Power Button	1
Power LED	1
HDD LED	1
LAN Status LED	2 sets
USB	2 x USB 2.0
Reset	1
Rear I/O	
VGA	1
DVI-D	1
HDMI	1
Ethernet	2 x RJ45
Audio	Mic-in, Line-out
COM	1x RS232/422/485 with 5V/12V selectable
USB	4 x USB 3.0
Pre-cut hole	1 x D-sub pre-cut hole
DC-in	1 x 3-pin Terminal Block
Mechanical & Environment	
Power Requirements	13V to 35V DC-in
Dimension (W x H x D)	440 x 44 x 380mm (17.32" x 1.73" x 14.96")
Operating Temp.	-20 to 70°C (ambient with air flow)
Storage Temp.	-20 to 80°C
Relative Humidity	10% to 90%, non-condensing
Certification	CE, FCC

Specifications are subject to change without notice

1.2 Front Panel Components



1	LAN Status LED
2	USB 2.0 x 2
3	HDD LED
4	Reset Button
5	Power LED
6	Power Button

1.3 Rear Panel Components

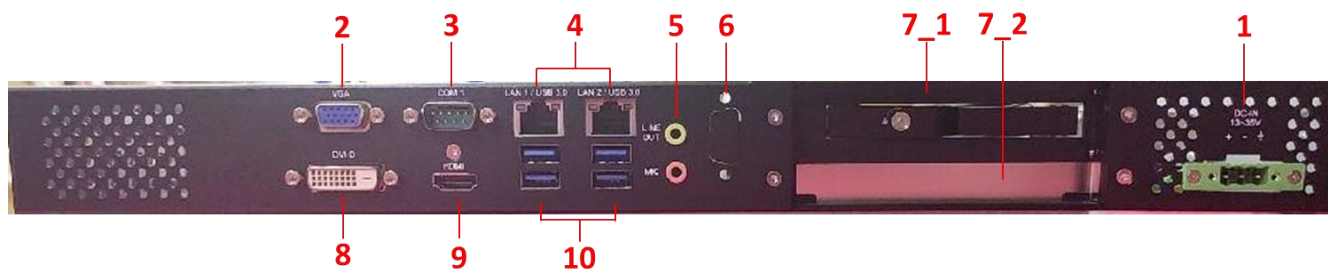

1	Power Input 13V to 35V DC-in (by terminal block)
2	VGA port
3	COM port, RS232/422/485 with 5V/12V selectable
4	LAN port, 2 x RJ45
5	Audio jack (Mic-in, Line-out)
6	Pre-cut hole for D-sub connector
7_1	1x Swappable SSD Tray [in an Expansion slot (PCI)]
7_2	1x Expansion slot (PCI)
8	DVI-D port
9	HDMI port
10	4 x USB 3.0

1.4 Mechanical Dimensions

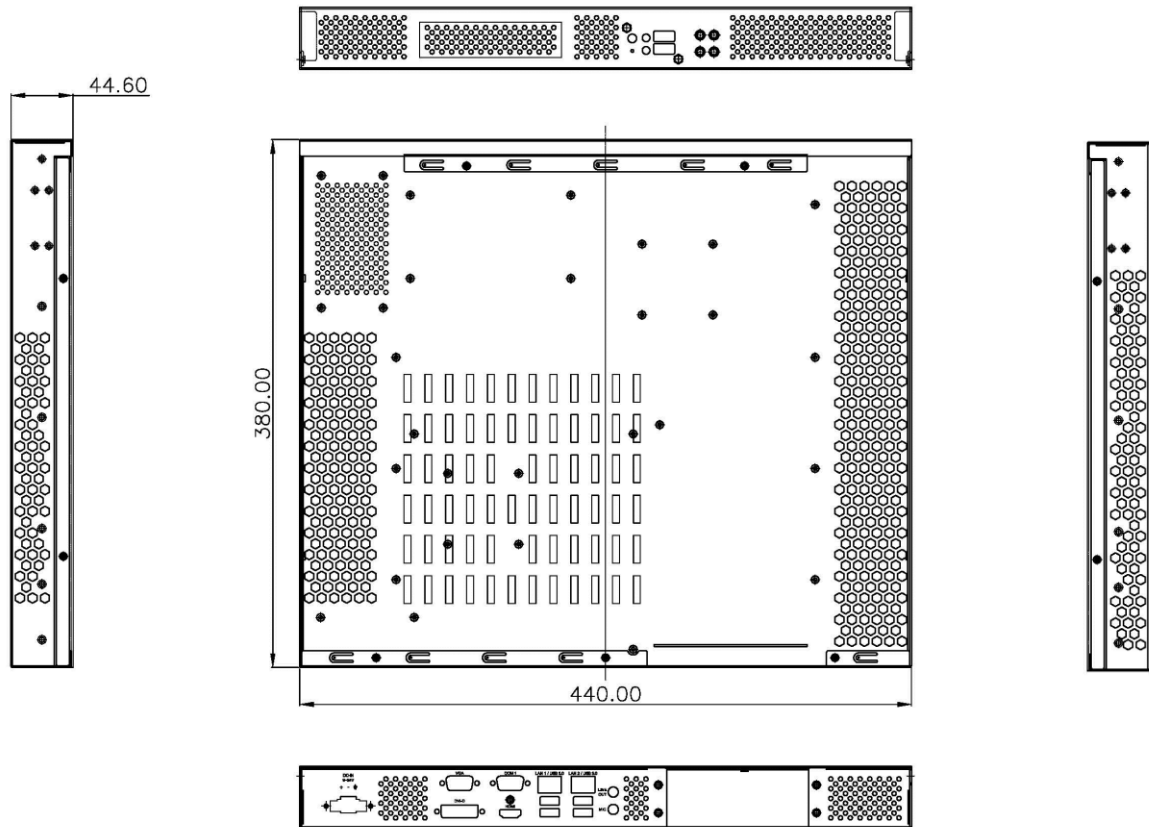

Chapter 2: Jumpers and Connectors



2.1 Front Panel Connector Pin Definitions

USB Port: USB2.0

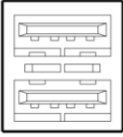







Pin	Definition	Pin	Definition
1	+5V	5	+5V
2	USBD-	6	USBD-
3	USBD+	7	USBD+
4	GND	8	GND



Status Indicators

Status	LED Color	
HDD	RED	<p>HDD</p>   <p>PWR</p>
PWR	BLUE	

SPEED LED:	ACTIVE 1 LED:	ACTIVE 2 LED:
RED: 1000Mbps	ORANGE (BLINKING): ACTIVITY	ORANGE (BLINKING): ACTIVITY
GREEN: 100Mbps	ORANGE (NO BLINKING): ACTIVITY	ORANGE (NO BLINKING): ACTIVITY

<p>ACT1</p>   <p>1000Mbps</p>	<p>ACT2</p>   <p>1000Mbps</p>	<p>ACT1</p>   <p>100Mbps</p>	<p>ACT2</p>   <p>100Mbps</p>
--	--	---	---

2.2 Rear Panel Connector Pin Definitions

LAN1_USB12: USB3.0 port 0,1 and LAN connector 1

LAN2_USB34: USB3.0 port 3,4 and LAN connector 2

Upper USB		Lower USB		LAN	
Pin	Definition	Pin	Definition	Pin	Definition
1	+5VDUAL	1	+5VDUAL	1	D0+
2	D-	2	D-	2	D0-
3	D+	3	D+	3	D1+
4	GND	4	GND	4	D1-
5	StdA_SSTX-	5	StdA_SSTX-	5	D2+
6	StdA_SSTX+	6	StdA_SSTX+	6	D2-
7	GND_DRIAN	7	GND_DRIAN	7	D3+
8	StdA_SSRX-	8	StdA_SSRX-	8	D3-
9	StdA_SSRX-	9	StdA_SSRX-		
SPEED LED: (Lift)			ACTIVE LED: (Right)		
GREEN: 1000Mbps			ORANGE (BLINKING): ACTIVITY		
ORANGE: 100Mbps			No Light: NOT LINK		
No Light: 10Mbps			ORANGE (NO BLINKING): LINK		

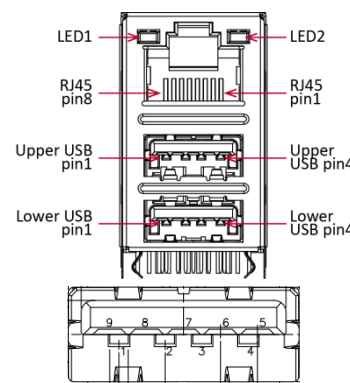
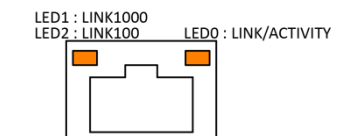
AUDIO1: LINE-OUT/MIC-IN

Pin	Definition
1	Line-out
2	Mic-in

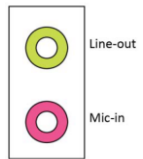

DVI-D: DVI-D

Pin	Definition	Pin	Definition
1	TMDS2-	13	NC
2	TMDS2+	14	+5V
3	GND	15	GND
4	NC	16	HOTPLUG_DETECT
5	NC	17	TMDS0-
6	DDC_CLK	18	TMDS0+
7	DDC_DATA	19	GND
8	NC	20	NC
9	TMDS1-	21	NC
10	TMDS1+	22	GND
11	GND	23	TMDSCLK+
12	NC	24	TMDSCLK-

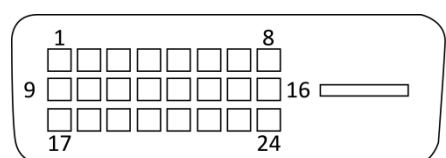

VGA: VGA

Pin	Definition	Pin	Definition
1	RED	9	+5V
2	GREEN	10	GND
3	BLUE	11	NC
4	NC	12	DDC DATA
5	GND	13	HSYNC
6	GND	14	VSYNC
7	GND	15	DDC LOCK
8	GND		

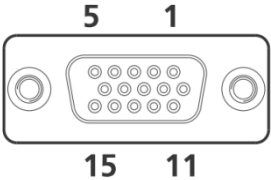

A diagram of a 15-pin D-sub connector. The pins are arranged in three rows: the top row has pins 5 and 1; the middle row has pins 15 and 11; and the bottom row has pins 13, 12, 14, and 10. Pins 9 and 16 are not shown in this diagram.

HDMI: HDMI

Pin	Definition	Pin	Definition
1	HDMI_2P	11	GND
2	GND	12	HDMI_CLKN
3	HDMI_2N	13	NC
4	HDMI_1P	14	NC
5	GND	15	DDC CLOCK
6	HDMI_1N	16	DDC DATA
7	HDMI_0P	17	GND
8	GND	18	+5V
9	HDMI_0N	19	HOTPLUG_DETECT
10	HDMI_CLKP		

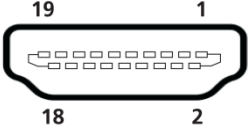

A diagram of a 19-pin HDMI connector. The pins are arranged in a single row. Pin 19 is at the top left, pin 1 is at the top right, pin 18 is at the bottom left, and pin 2 is at the bottom right.

COM1: RS232/422/485 with +12V/+5V selection

Pin	RS-232	RS-422	Half Duplex RS-485
1	DCD-	TX-	DATA-
2	RXD	RX+	NA
3	TXD	TX+	DATA+
4	DTR-	RX-	NA
5	GND	GND	GND
6	DSR-	NA	NA
7	RTS-	NA	NA
8	CTS-	NA	NA
9	COM1P9SEL (Define by JP5)	COM1P9SEL (Define by JP5)	COM1P9SEL (Define by JP5)

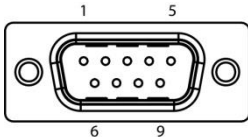

A diagram of a 9-pin D-sub connector. The pins are arranged in three rows: the top row has pins 1 and 5; the middle row has pins 6 and 9; and the bottom row has pins 3, 2, 4, and 8.

MINI_MPCIE: Mini PCIe connector

Pin	Definition	Pin	Definition
1	WAKE#	2	+3.3VAUX
3	NC	4	GND
5	NC	6	+1.5V
7	CLKREQ#	8	NC
9	GND	10	NC
11	REF CLK-	12	NC
13	REF CLK+	14	NC
15	GND	16	NC
17	NC	18	GND
19	NC	20	Wireless LAN Disable#
21	GND	22	RESET#
23	RXN	24	+3.3VAUX
25	RXP	26	GND
27	GND	28	+1.5V
29	GND	30	SMBUS CLOCK
31	TXN	32	SMBUS DATA
33	TXP	34	GND
35	GND	36	USB DATA-
37	GND	38	USB DATA+
39	+3.3VAUX	40	GND
41	+3.3VAUX	42	NC
43	GND	44	NC
45	Control Link CLOCK	46	NC
47	Control Link DATA	48	+1.5V
49	Control Link RESET#	50	GND
51	Blue Tooth Disable#	52	+3.3V VAUX

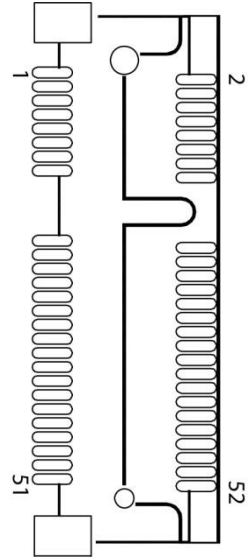

2.3 Internal Connectors

SATA1, SATA2: Serial ATA 3.0 Connector

Pin	Definition
1	GND
2	TXP
3	TXN
4	GND
5	RXN
6	RXP
7	GND

SATA3, SATA4: Serial ATA 2.0 Connector

Pin	Definition
1	GND
2	TXP
3	TXN
4	GND
5	RXN
6	RXP
7	GND

SATA0, SATAP1: SATA Power Connector

Pin	Definition
1	+5V
2	GND
3	GND
4	+12V

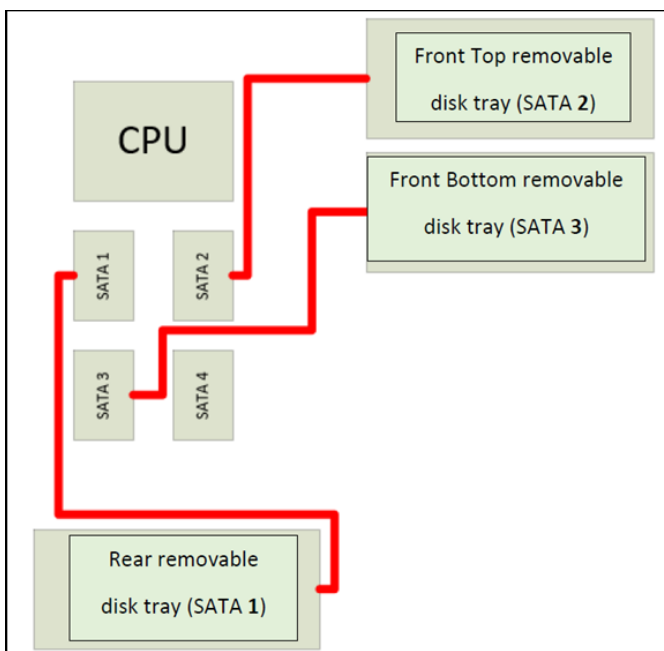

PCI: PCI

Pin	Definition	Pin	Definition	Pin	Definition	Pin	Definition
A1	Pull down 4.7K to GND	A32	AD16	B1	-12V	B32	AD17
A2	+12V	A33	+3.3	B2	GND	B33	CBE2#
A3	GND	A34	FRAME#	B3	GND	B34	GND
A4	GND	A35	GND	B4	NC	B35	IRDY#
A5	+5V	A36	TRDY#	B5	+5V	B36	+3.3V
A6	INTA#	A37	GND	B6	+5V	B37	DEVSEL#
A7	INTC#	A38	STOP#	B7	INTB#	B38	GND
A8	+5V	A39	+3.3V	B8	INTD#	B39	LOCK#
A9	GNT1#	A40	SMBUS CLOCK	B9	NC	B40	PERR#
A10	+5V	A41	SMBUS DATA	B10	REQ1#	B41	+3.3V
A11	NC	A42	GND	B11	NC	B42	SERR#
A12	GND	A43	PAR	B12	GND	B43	+3.3V
A13	GND	A44	AD15	B13	GND	B44	CBE1#
A14	+3.3VAUX	A45	+3.3V	B14	CLOCK1	B45	AD14
A15	RESET#	A46	AD13	B15	GND	B46	GND
A16	+5V	A47	AD11	B16	CLOCK0	B47	AD12
A17	GNT0#	A48	GND	B17	GND	B48	AD10
A18	GND	A49	AD9	B18	REQ0#	B49	GND
A19	PCI PME#	A50	Keyway	B19	+5V	B50	Keyway
A20	AD30	A51	Keyway	B20	AD31	B51	Keyway
A21	+3.3V	A52	CBE0#	B21	AD29	B52	AD8
A22	AD28	A53	+3.3V	B22	GND	B53	AD7
A23	AD26	A54	AD6	B23	AD27	B54	+3.3V
A24	GND	A55	AD4	B24	AD25	B55	AD5
A25	AD24	A56	GND	B25	+3.3V	B56	AD3
A26	AD20	A57	AD2	B26	CBE3#	B57	GND
A27	+3.3V	A58	AD0	B27	AD23	B58	AD1
A28	AD22	A59	+5V	B28	GND	B59	+5V
A29	AD20	A60	REQ64#	B29	AD21	B60	ACK64#
A30	GND17	A61	+5V	B30	AD19	B61	+5V
A31	AD18	A62	+5V	B31	+3.3V	B62	+5V

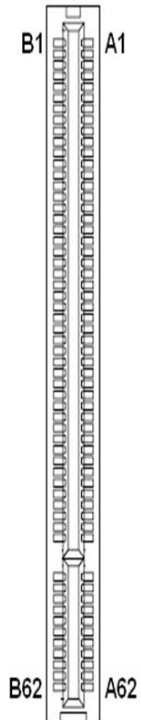

Chapter 3: System Setup

This chapter provides more detailed information and let you know how to install components into the ROC235A embedded System.



Prior to removing the chassis cover, make sure the unit's power is off and disconnected from the power sources to prevent electric shock or system damage.

3.1 2.5" SATA SSD installation

ROC235A supports 2 x 2.5" SATA HDD/SSD

5. Install/remove the SSD into/from the front SSD swappable tray.

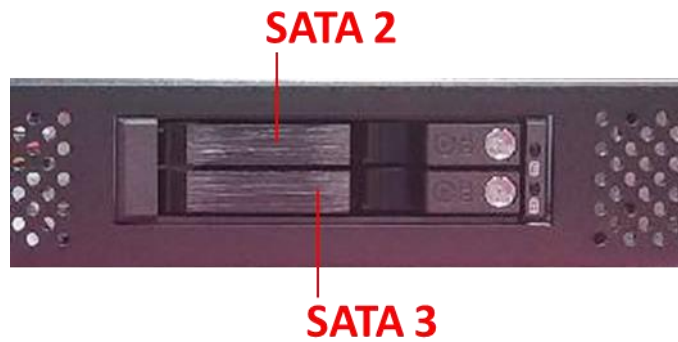

6.

Open the Tray._____



7.

Plug in to the 2.5" SSD

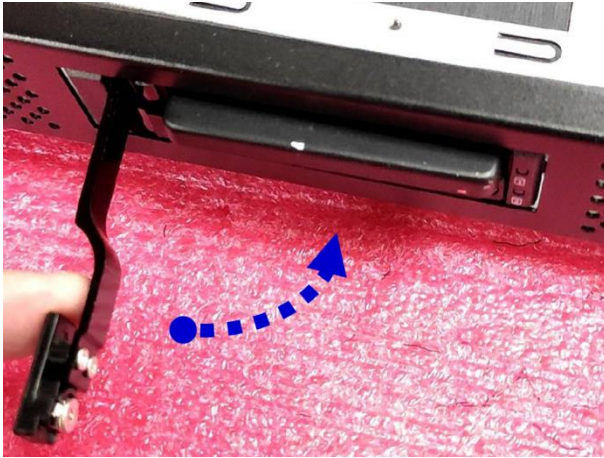

8. Push in the SSD with tray

9. Install/Remove the SSD into/from the rear Swappable tray.

SATA 1



10. Open the Tray.

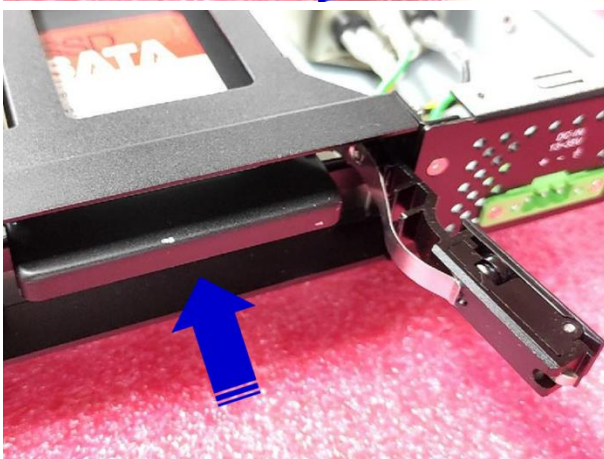

11. Plug in to the 2.5" SSD



12.

Push in the SSD with tray

3.2 CPU installation

ROC235A supports Intel® 22nm Ivy Bridge Processor (Mobile) socket (rPGA988)
Core™ i7-3610QE (4C x 3.3 GHZ), 6M L2 cache (45W)
Core™ i5-3610ME (2C x 2.7 GHZ), 3M L2 cache (35W)
Core™ i3-3120ME (2C x 2.4 GHZ), 3M L2 cache (35W)

7. Remove 4 screws from CPU heat sink's cover, and 4 screws of left bracket from system heat sink.

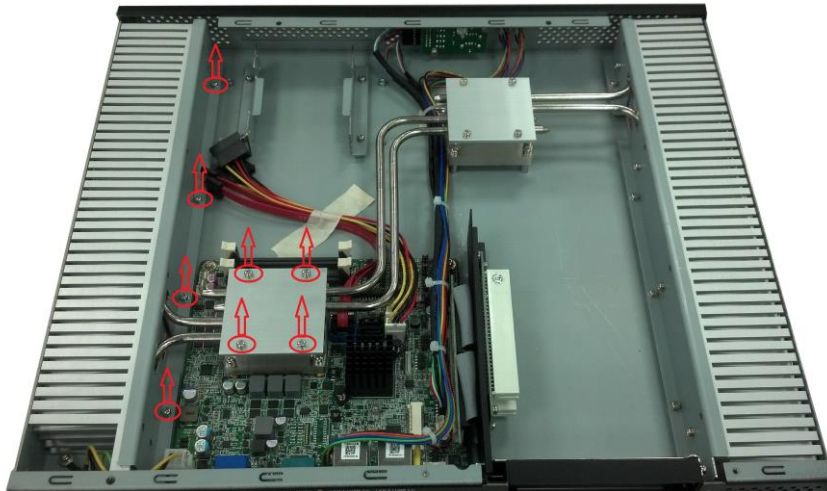

8. Take off the CPU heat sink's cover.



9. Pull out the heatsink on the left side.

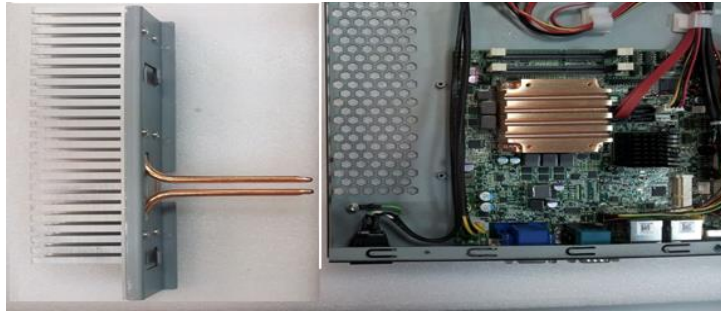

10. Unscrew two of screws on system heat sink, and pull the heat pipe up from CPU heat sink. Drive 4 screws off to remove CPU heat sink.

PS: ROC235A-ESK had removed the right heat sink and replaced by a new power Module for 13~35V DC-IN. (Refer the right picture)

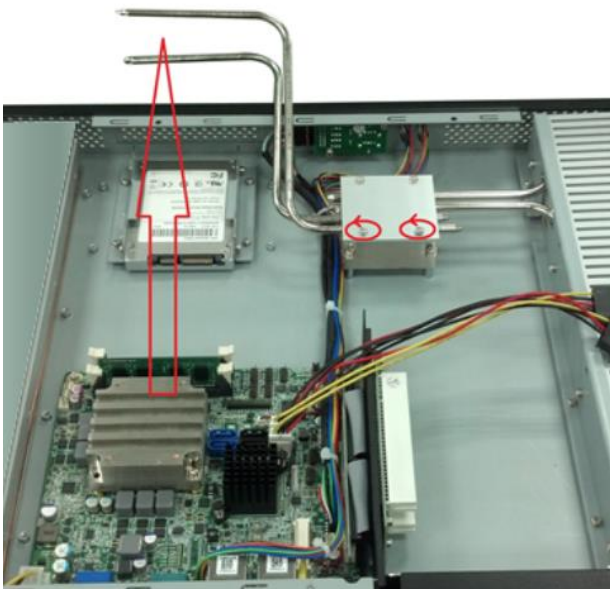

ROC235A-ET/UT



ROC235A-ESK

11. After pick up CPU heat sink you can set CPU on CPU socket.



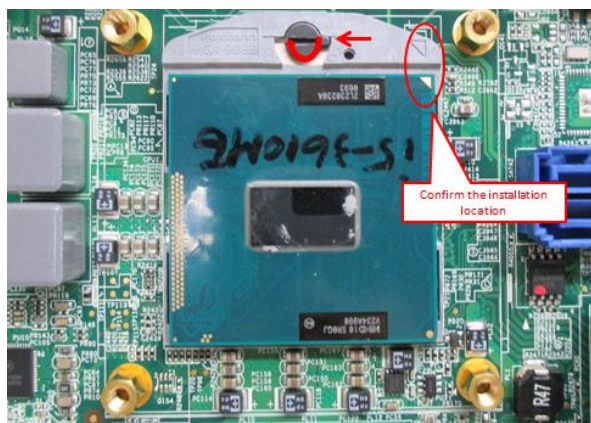

12. Put the thermal pad (P/N: 0R0100250160000L) on the CPU, screw the system heatsink back, put the heat sink with heatpipe back on the left side, screw the heatsink's cover back, then fasten 4 screws of left bracket from system heat sink.
thermal pad



3.3 Memory module installation

ROC235A supports 2 x 204-pin SO-DIMM DDR3 1333/1600 MHz up to 16GB

3. Remove the top case and locate 2 memory slots on the motherboard.
4. Insert the RAM into the RAM slot. Align the notch on the module with the notch in the slot, and then apply equal pressure onto the stick until the clamps on the side click and lock the RAM in. You may have to apply a fair amount of pressure, but never force it in.

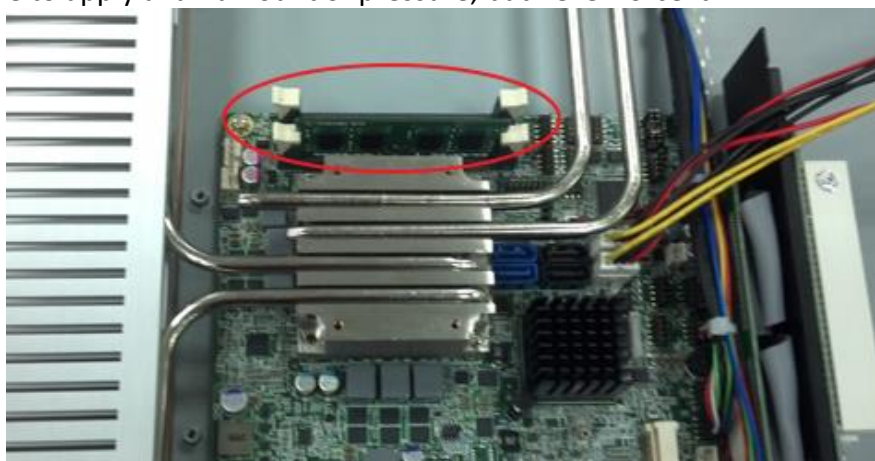

3.4 PCI riser card installation

ROC235A supports 2 x PCI expansion slots.

Before PCI card installation, you have to remove the Swappable tray. Remove the two screws then release the tray.



6. Drive each 5 screws off as the marks for remove riser card.

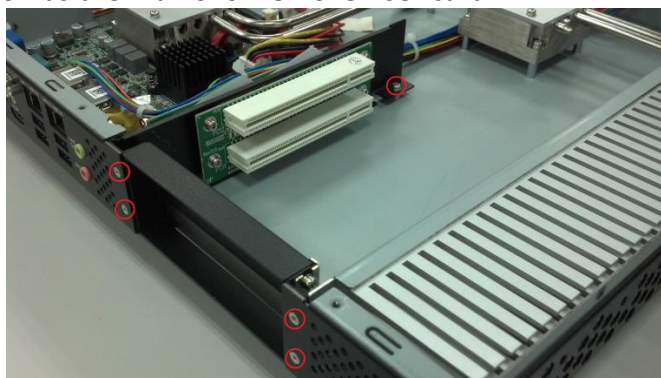

7. Remove the screws to set PCI add-on card on PCI riser card.



8. Insert PCI add-on card into PCI slot from riser card.



9. Insert add-on card screw to firm the add-on card, and insert the PCI riser's bridge board to motherboard PCI slot.

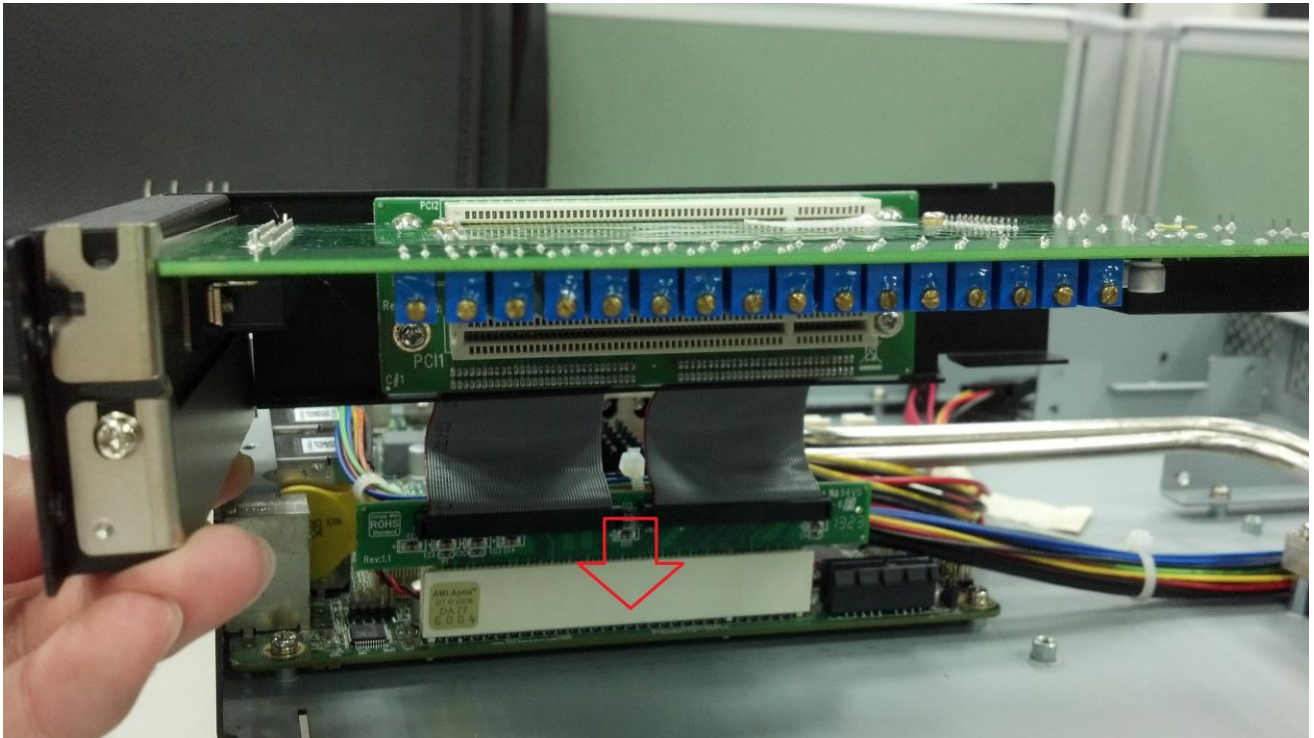

10. Insert PCI riser back to system and lock each screws.

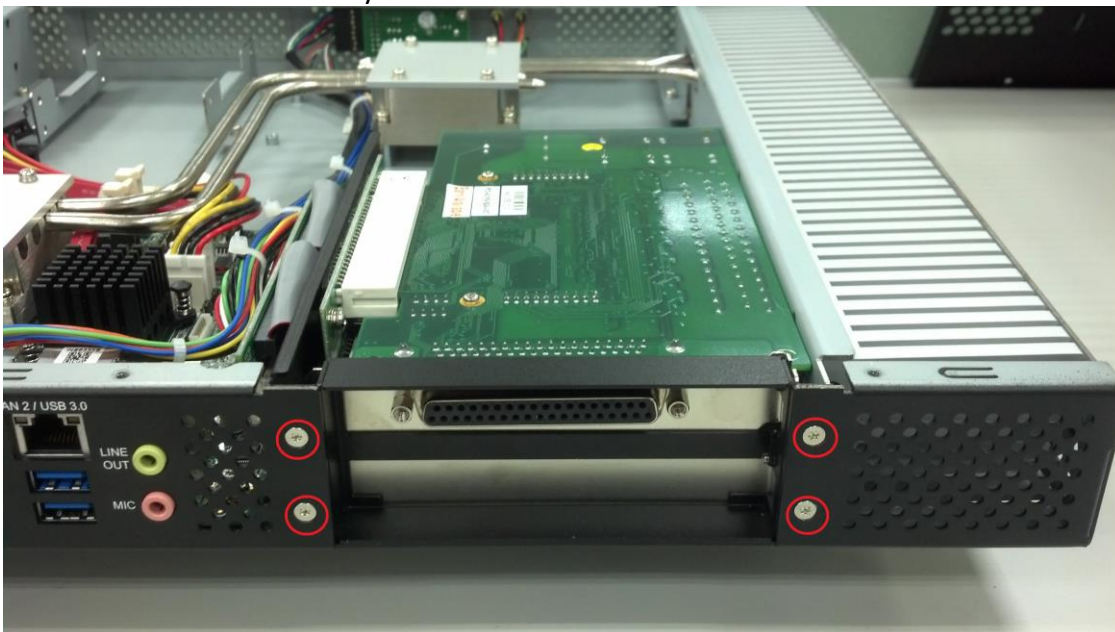

3.5 Rack mount bracket installation

For install rack mount bracket, insert each screws (P/N: 0F0130600600000L and 0F0132700800000L) as red spot screw holes to firmed the bracket.



Chapter 4: AMI BIOS UTILITY

This chapter provides users with detailed descriptions on how to set up a basic system configuration through the AMI BIOS setup utility.

4.1 Starting

To enter the setup screens, perform the following steps:

- Turn on the computer and press the key immediately.
- After the key is pressed, the main BIOS setup menu displays. Other setup screens can be accessed from the main BIOS setup menu, such as the Chipset and Power menus.

4.2 Navigation Keys

The BIOS setup/utility uses a key-based navigation system called hot keys. Most of the BIOS setup utility hot keys can be used at any time during the setup navigation process.

Some of the hot keys are <F1>, <F10>, <Enter>, <ESC>, and <Arrow> keys.



Some of the navigation keys may differ from one screen to another.

Left/Right	The Left and Right <Arrow> keys moves the cursor to select a menu.
Up/Down	The Up and Down <Arrow> keys moves the cursor to select a setup screen or sub-screen.
+– Plus/Minus	The Plus and Minus <Arrow> keys changes the field value of a particular setup setting.
Tab	The <Tab> key selects the setup fields.
F1	The <F1> key displays the General Help screen.
F10	The <F10> key saves any changes made and exits the BIOS setup utility.
Esc	The <Esc> key discards any changes made and exits the BIOS setup utility.
Enter	The <Enter> key displays a sub-screen or changes a selected or highlighted option in each menu.

4.3 Main Menu

The Main menu is the first screen that you will see when you enter the BIOS Setup Utility.

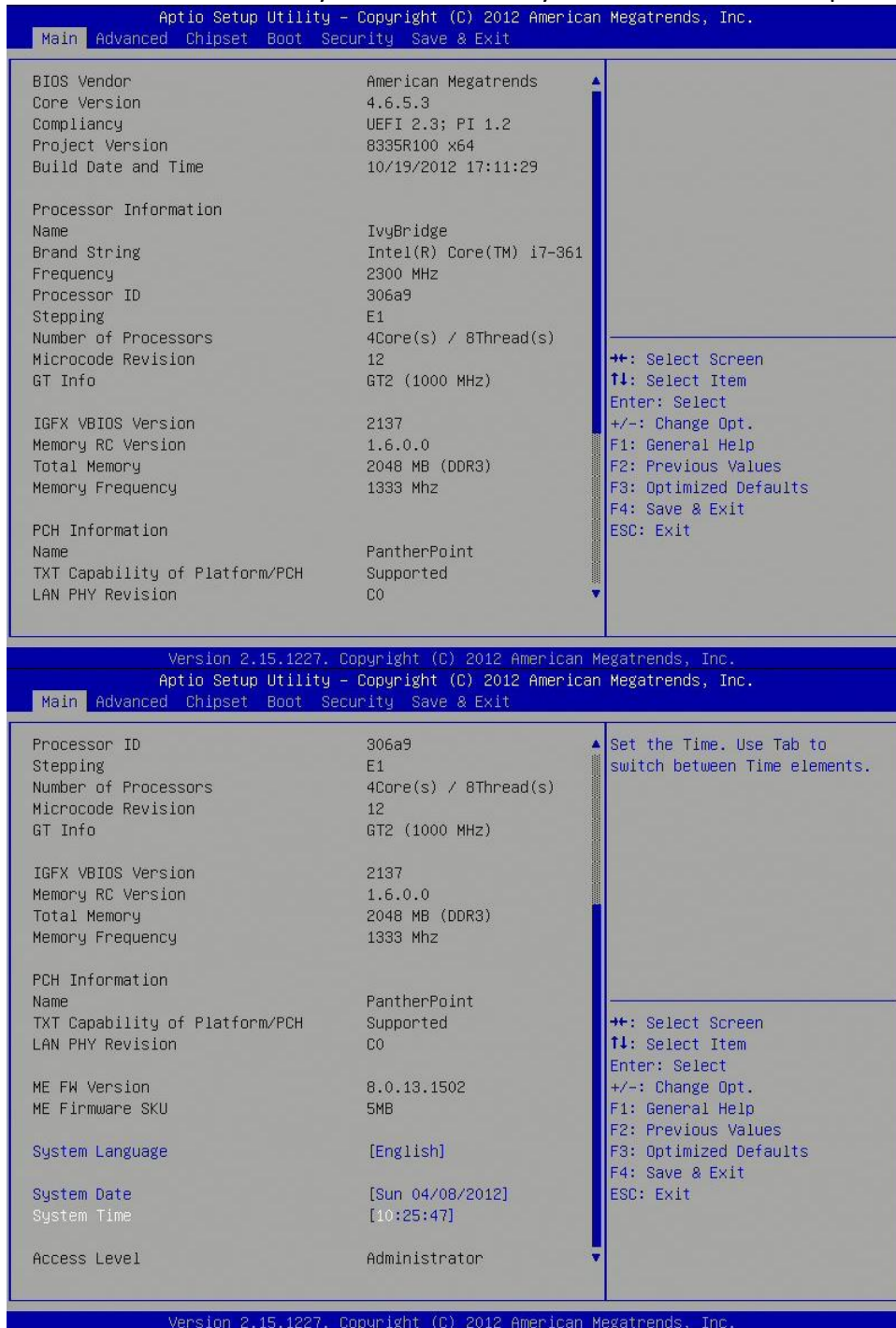

System Language

Use this function to select the system language.

System Date

Use this function to change the system date.

Select System Date using the Up and Down <Arrow> keys. Enter the new values through the keyboard. Press the Left and Right <Arrow> keys to move between fields.

The date setting must be entered in MM/DD/YY format.

System Time

Use this function to change the system time.

Select System Time using the Up and Down <Arrow> keys. Enter the new values through the keyboard. Press the Left and Right <Arrow> keys to move between fields.

The time setting is entered in HH:MM:SS format.

Note: The time is in 24-hour format. For example, 5:30 A.M. appears as 05:30:00, and 5:30 P.M. as 17:30:00.

Access Level

Displays the access level of the current user in the BIOS.

4.4 Advanced Menu

The Advanced Menu allows you to configure your system for basic operation. Some entries are defaults required by the system board, while others, if enabled, will improve the performance of your system or let you set some features according to your preference. **Setting incorrect field values may cause the system to malfunction.**

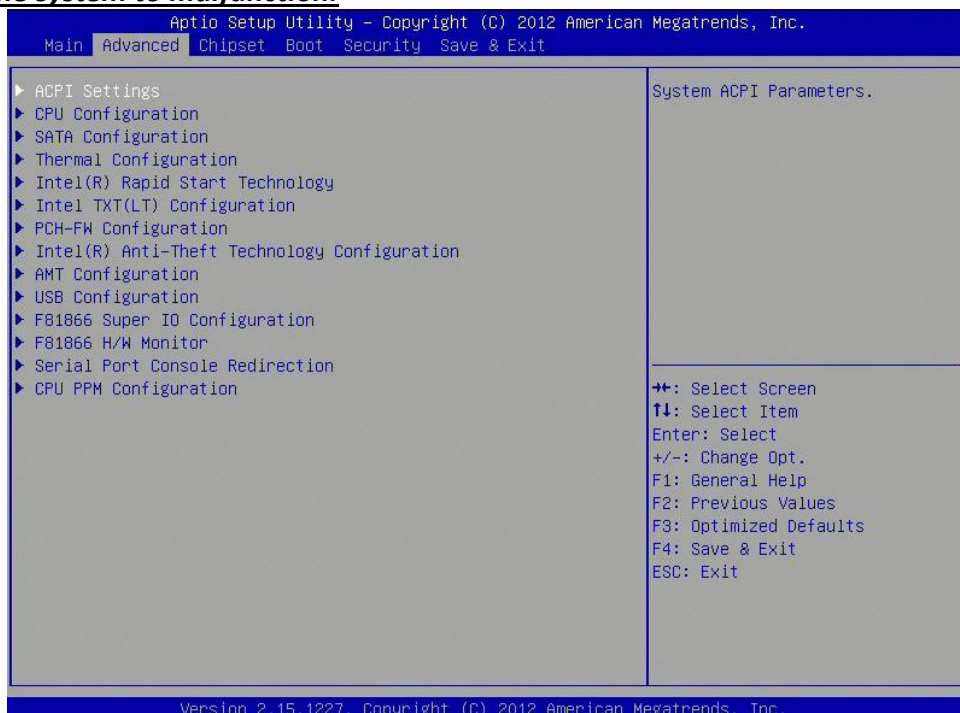

4.4.1 ACPI Settings

System ACPI parameters

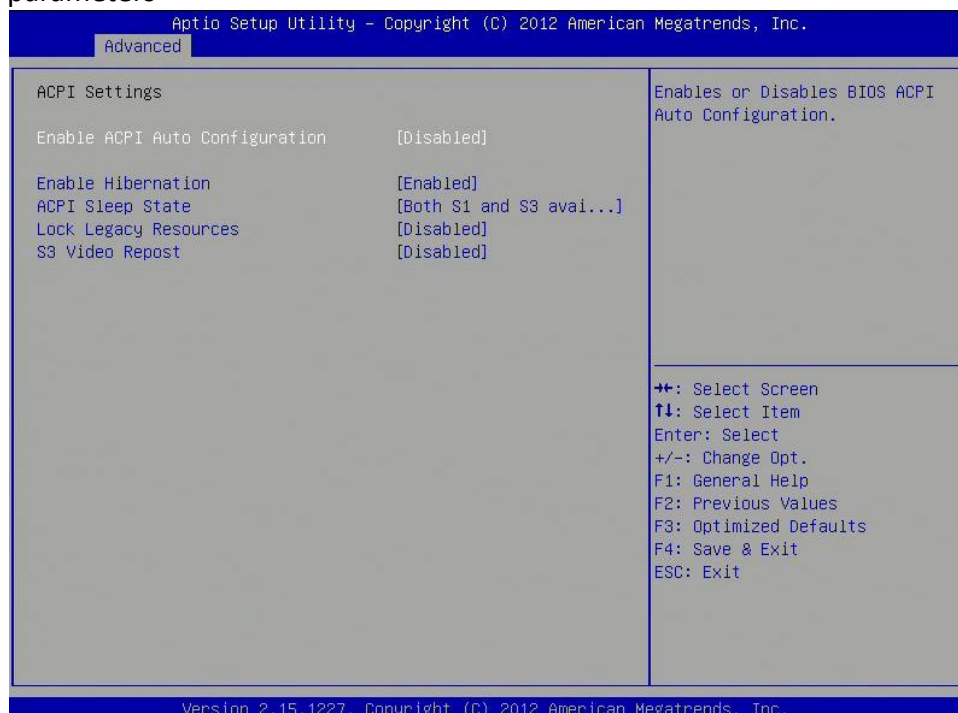

Enable ACPI Auto Configuration

Enables or disables BIOS ACPI auto configuration.

Enable Hibernation

Enables or disables system ability to hibernate (OS/S4 Sleep State). This option may not be effective with some OS.

ACPI Sleep State

Select the ACPI sleep state the system will enter when the suspend button is pressed.

Lock Legacy Resources

Enables or Disables System Lock of Legacy Resources.

S3 Video Repost

Enable or disable S3 Video Repost.

4.4.2 CPU Configuration

This section is used to configure the CPU.

Aptio Setup Utility - Copyright (C) 2012 American Megatrends, Inc.

Advanced

CPU Configuration		Enabled for Windows XP and Linux (OS optimized for Hyper-Threading Technology) and Disabled for other OS (OS not optimized for Hyper-Threading Technology). When Disabled only one thread per enabled core is enabled.
Intel(R) Core(TM) i7-3610QE CPU @ 2.30GHz		
CPU Signature	306a9	↑: Select Screen ↓: Select Item Enter: Select +/-: Change Opt. F1: General Help F2: Previous Values F3: Optimized Defaults F4: Save & Exit ESC: Exit
Microcode Patch	12	
Max CPU Speed	2300 MHz	
Min CPU Speed	1200 MHz	
CPU Speed	2300 MHz	
Processor Cores	4	
Intel HT Technology	Supported	
Intel VT-x Technology	Supported	
Intel SMX Technology	Supported	
64-bit	Supported	
L1 Data Cache	32 KB x 4	
L1 Code Cache	32 KB x 4	
L2 Cache	256 KB x 4	
L3 Cache	6144 KB	
Hyper-threading	[Enabled]	
Active Processor Cores	[All]	
Limit CPUID Maximum	[Disabled]	
Execute Disable Bit	[Enabled]	
Intel Virtualization Technology	[Enabled]	
Hardware Prefetcher	[Enabled]	

Version 2.15.1227. Copyright (C) 2012 American Megatrends, Inc.

Aptio Setup Utility - Copyright (C) 2012 American Megatrends, Inc.

Advanced

Microcode Patch		The Maximum instantaneous current allow for Secondary Plane
Microcode Patch	12	
Max CPU Speed	2300 MHz	↑: Select Screen ↓: Select Item Enter: Select +/-: Change Opt. F1: General Help F2: Previous Values F3: Optimized Defaults F4: Save & Exit ESC: Exit
Min CPU Speed	1200 MHz	
CPU Speed	2300 MHz	
Processor Cores	4	
Intel HT Technology	Supported	
Intel VT-x Technology	Supported	
Intel SMX Technology	Supported	
64-bit	Supported	
L1 Data Cache	32 KB x 4	
L1 Code Cache	32 KB x 4	
L2 Cache	256 KB x 4	
L3 Cache	6144 KB	
Hyper-threading	[Enabled]	
Active Processor Cores	[All]	
Limit CPUID Maximum	[Disabled]	
Execute Disable Bit	[Enabled]	
Intel Virtualization Technology	[Enabled]	
Hardware Prefetcher	[Enabled]	
Adjacent Cache Line Prefetch	[Enabled]	
TCC Activation offset	10	
Primary Plane Current value	0	
Secondary Plane Current value	0	

Version 2.15.1227. Copyright (C) 2012 American Megatrends, Inc.

Hyper-threading

Enabled for Windows XP and Linux (OS optimized for Hyper-Threading Technology) and Disabled for other OS (OS not optimized for Hyper-Threading Technology). When disabled only one thread per enabled core is enabled.

Active Processor Cores

Number of cores to enable in each processor package.

Limit CPUID Maximum

Disabled for Windows XP.

Execute Disable Bit

XD can prevent certain classes of malicious buffer overflow attacks when combined with a supporting OS (Windows Sever 2003 SP1, Windows XP SP2, SuSE Linux 9.2, RedHat Enterprise 3 Update 3.)

Intel Virtualization Technology

When enabled, a VMM can utilize the additional hardware capabilities provided by Vanderpool Technology.

Hardware Prefetcher

To turn on/off the Mid Level Cache (L2) streamer prefetcher

Adjacent Cache Line Prefetcher

To turn on/off prefetching of adjacent cache lines

TCC Activation Offset

Offset from the factory TCC activation temperature

Primary Plane Current Value

The Maximum instantaneous current allow for primary plane

Secondary Plane Current Value

The Maximum instantaneous current allow for secondary plane

4.4.3 SATA Configuration

This section is used to configure the SATA drives.



SATA Controller(s)

Enable or disable SATA device.

SATA Mode Selection

Determines how SATA controller(s) operate.

SATA Test Selection

Enable or disable Test Mode

IDE Legacy/Native Mode Selection

IDE Legacy/Native Mode Selection

Serial ATA Port 0 – 5

Displays information on the SATA devices detected

4.4.4 Thermal Configuration

Platform thermal configuration options



4.4.4.1 Platform thermal configuration

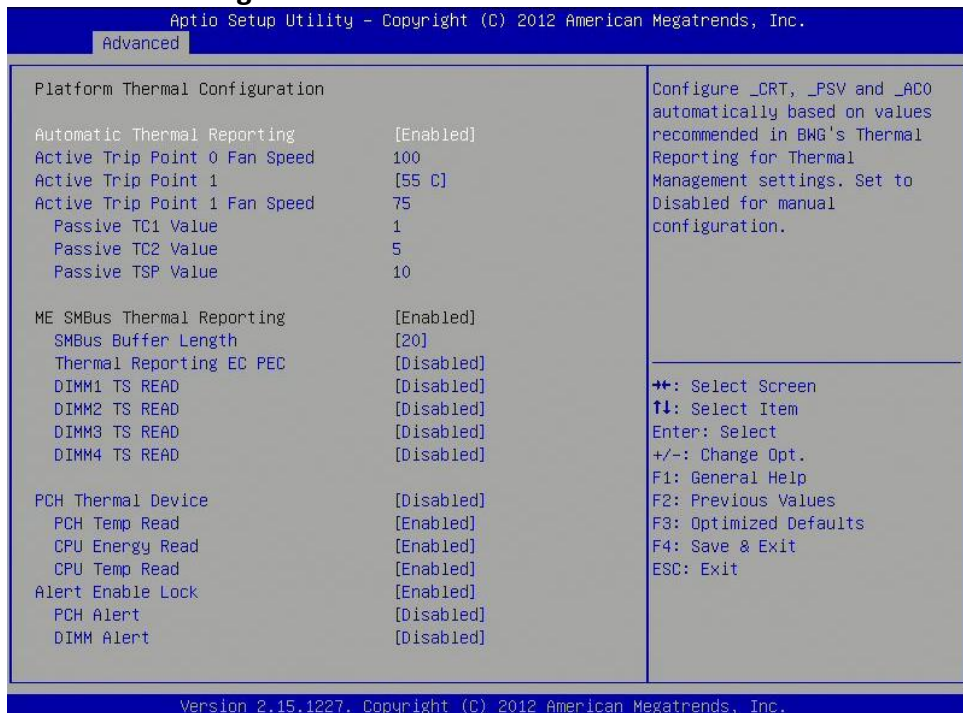

4.4.5 Intel Rapid Start Technology

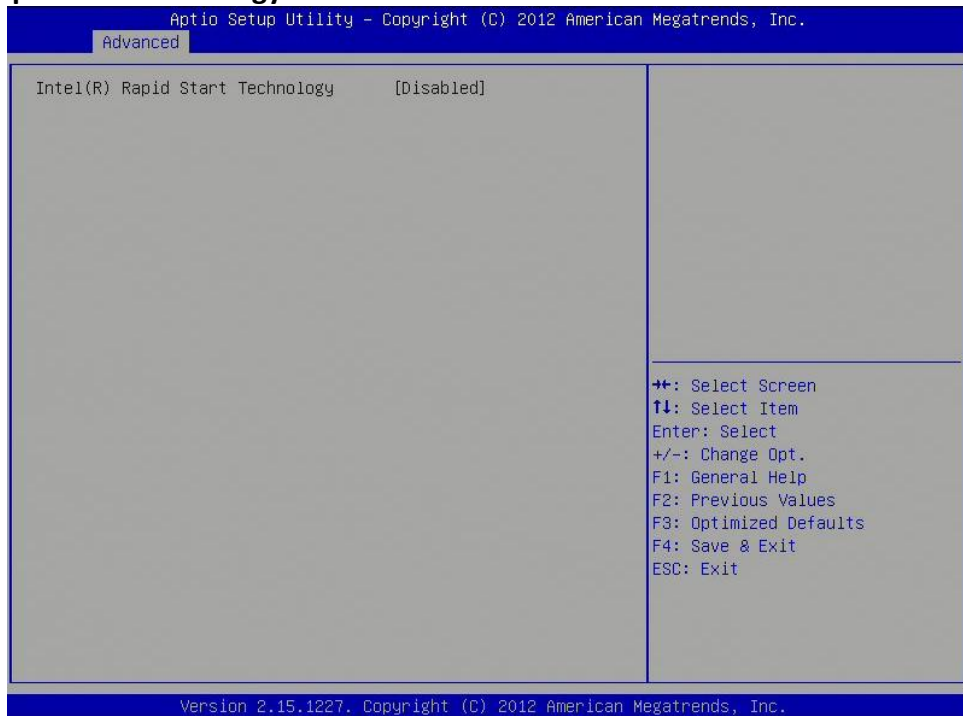

4.4.6 Intel TXT(LT) Configuration

Intel Trusted Execution Technology

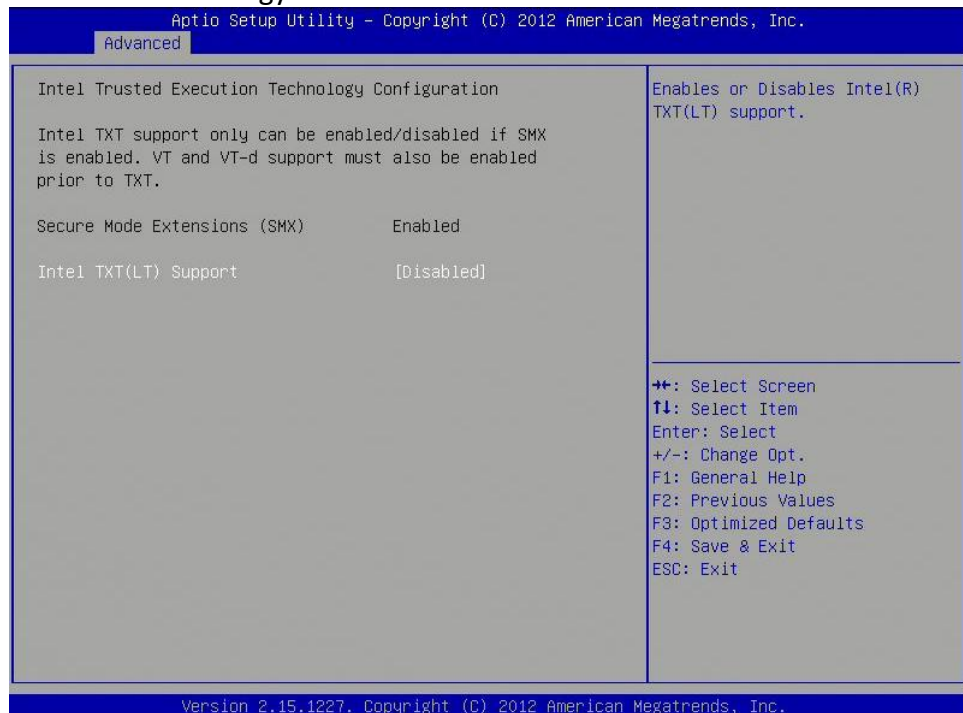

Intel TXT(LT) Support

Enables or disables Intel TXT(LT) support

4.4.7 PCH-FW Configuration

This section is used to configure Management Engine Technology parameters.

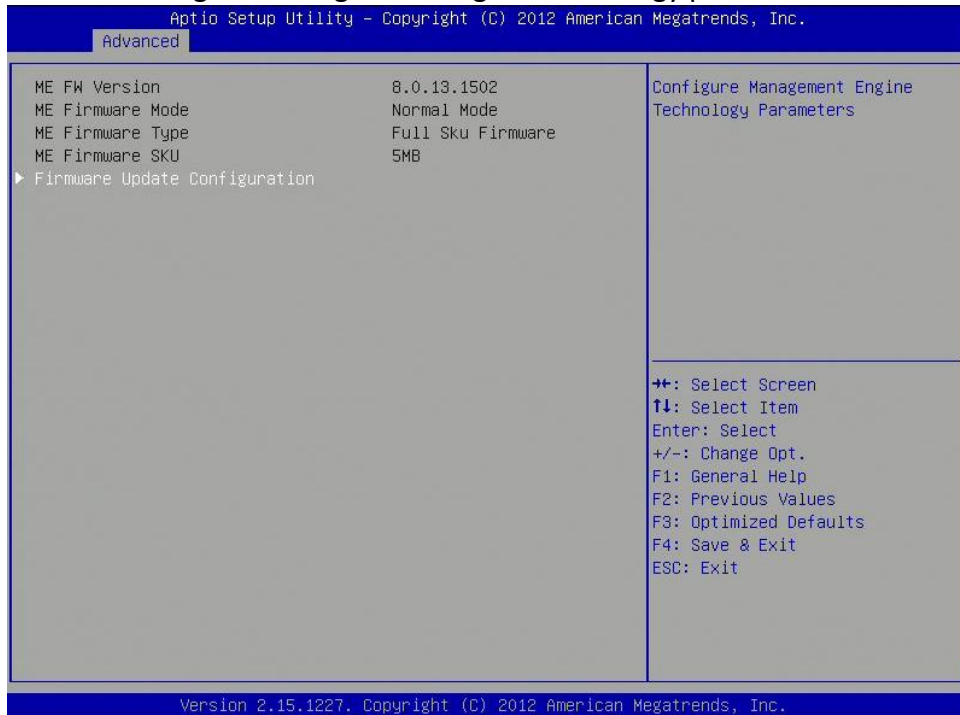

4.4.8 Intel Anti-Theft Technology Configuration

Disabling Intel AT allow user to login platform. This is strictly for testing only. This does not disable Intel AT services in ME



Intel Anti-Theft Technology

Enable or Disable Intel AT in BIOS for testing only

Intel Anti-Theft Technology Rec

Set the number of times Recovery attempted will be allowed.

4.4.9 AMT Configuration

This section is used to configure Active Management Technology (AMT) options.

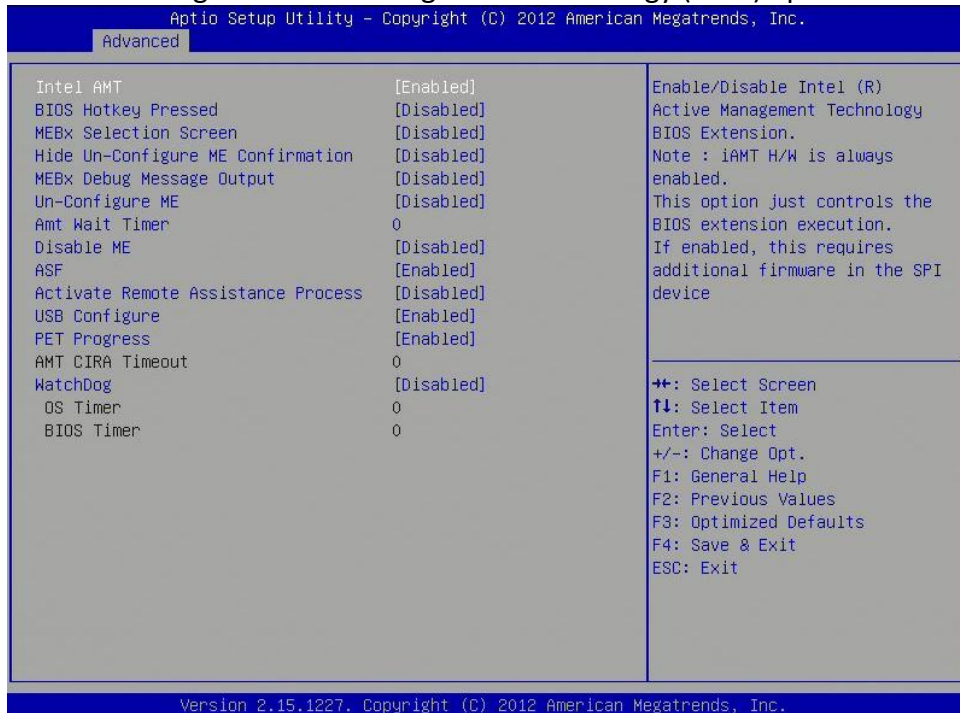

Intel AMT

Enable/disable Intel Active Management Technology BIOS extension.

Note: iAMT H/W is always enabled.

This option just controls the BIOS extension execution. If enabled, this requires additional firmware in the SPI device.

BIOS Hotkey Pressed

Enable/disable BIOS hotkey press.

MEBx Selection Screen

Enable/disable MEBx Selection Screen

Hide Un-Configure ME Confirmation

Hide Un-Configure ME without password confirmation prompt

MEBx Debug Message Screen

Enable MEBx debug message output

Un-Configure ME

Perform AMT/ME unconfigure without password operation.

Amt Wait Timer

Set timer to wait before sending ASF_GET_BOOT_OPTIONS.

Disable ME

Set ME to Soft Temporary Disabled

ASF

Enable/Disable Alert specification Format

Activate Remote Assistance Process

Trigger CIRA boot.

USB Configure

Enable/Disable USB configure function.

PET Progress

User can Enable/Disable PET Events progress to receive PET events or not.

Watchdog Timer

Enable/Disable Watchdog Timer.

4.4.10 USB Configuration

This section is used to configure the USB

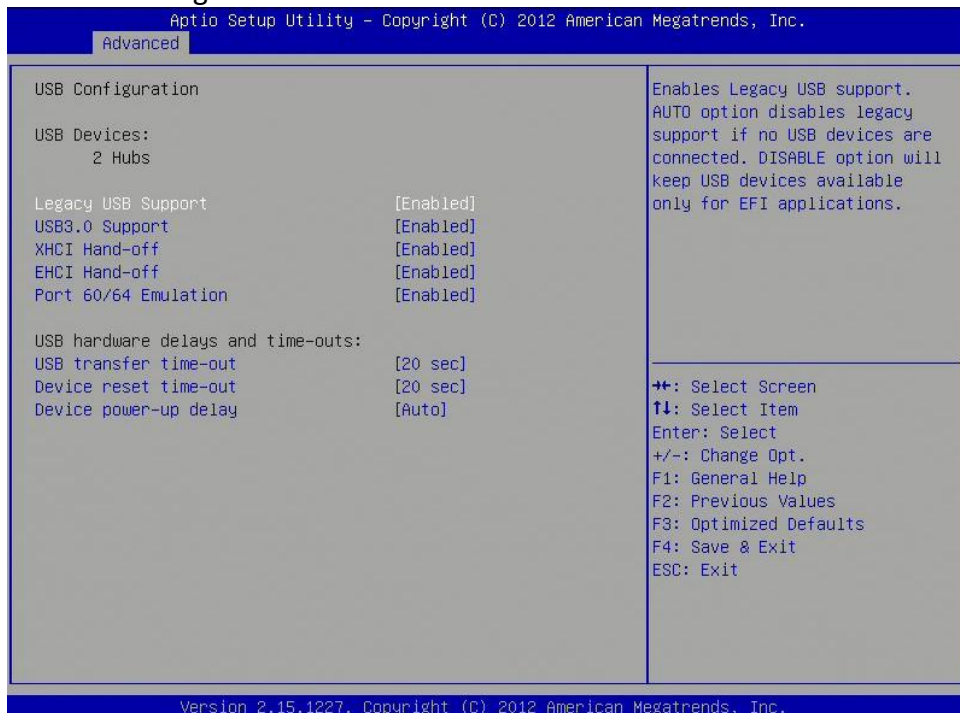

Legacy USB Support

Enables Legacy USB support.

AUTO option disables legacy support if no USB devices are connected.

DISABLE option will keep USB devices available only for EFI applications.

USB3.0 Support

Enable/Disable USB3.0 (XHCI) Controller support.

XHCI Hand-off

This is a workaround for OSes without XHCI hand-off support. The XHCI ownership change should be claimed by XHCI driver.

EHCI Hand-off

This is a workaround for OSes without EHCI hand-off support. The EHCI ownership change should be claimed by EHCI driver.

Port 64/60 Emulation

Enables I/O port 60h/64h emulation support. This should be enabled for the complete USB keyboard legacy support for non-USB aware OSes.

USB Transfer time-out

The time-out value for Control, Bulk, and Interrupt transfers.

Device reset time-out

USB mass Storage device start Unit command time-out.

Device power-up delay

Maximum time the device will take before it properly reports itself to the Host Controller. 'Auto' uses default value: for a Root port it is 100ms, for a Hub port the delay is taken from Hub descriptor.

4.4.11 F81866 Super IO Configuration

System super IO chip parameters

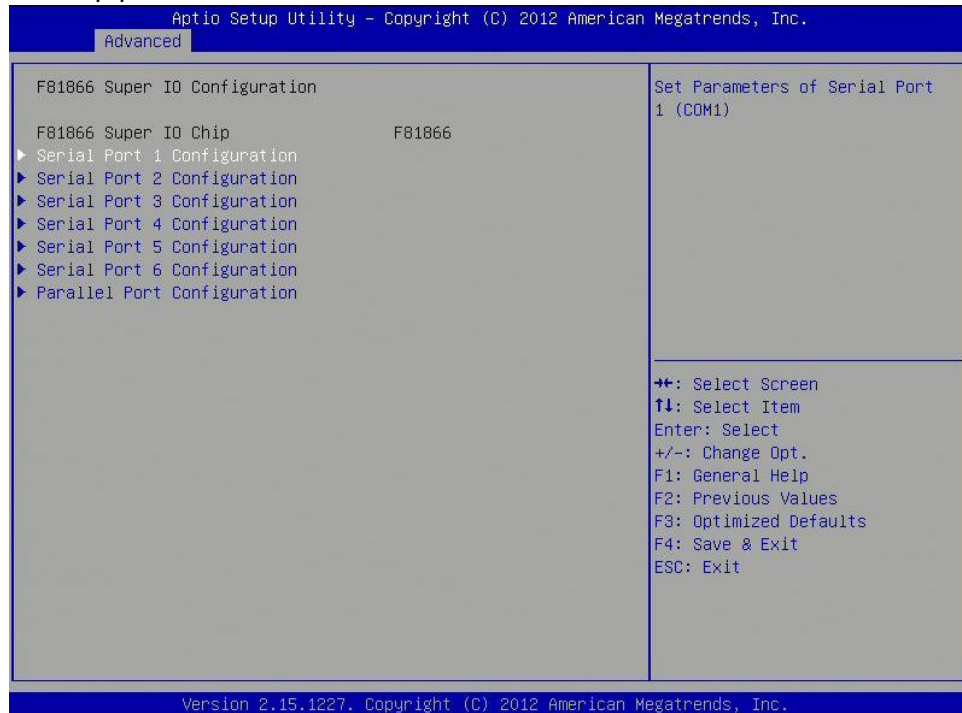

Serial Port Configuration

Set Parameters of Serial Ports. User can Enable/Disable the serial port and Select an optimal settings for the Super IO Device.

Parallel Port configuration

Set parameters of parallel port (LPT/LPTE)

4.4.12 F81866 H/W Monitor

This section is used to monitor hardware status such as temperature, fan speed and voltages.

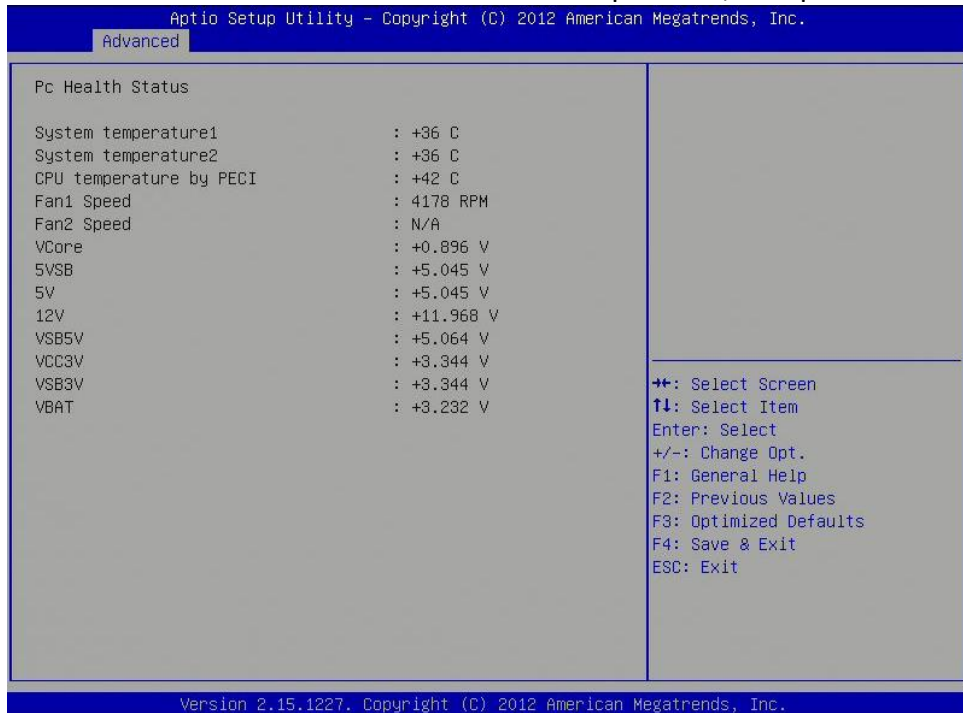

System Temperature

Detects and displays the current system temperature.

CPU Temperature

Detects and displays the current CPU temperature.

Fan1/2 Speed

Detects and displays the current CPU fan speed.

4.4.13 Serial Port Console Redirection

This screen provides information about functions for specifying the Serial Port Console Redirection configuration settings. Console redirection can be used to remotely operate system settings and the EFI console.



Console Redirection

Console Redirection Enable or Disable.

Console Redirection Settings

The setting specify how the host computer and the remote computer (which the user is using) will exchange data. Both computers should have the same or compatible settings.

4.4.14 CPU PPM Configuration

CPU PPM configuration parameters



EIST

Enables or disables Intel SpeedStep.

CPU C3 Report

Enable or disable CPU C3 (ACPI C2) report to OS.

Config TDP LOCK

Lock the Config TDP control register

Long duration power limit

Long duration power limit in Watts, 0 means use factory default.

Long duration maintained

Time window which the long duration power is maintained.

Short duration power limit

Short duration power limit in Watts, 0 means use factory default.

ACPI T State

Enable or disable ACPI state support.

4.5 Chipset

This section gives you functions to configure the system based on the specific features of the chipset. The chipset manages bus speeds and access to system memory resources.



4.5.1 PCH-IO Configuration

This section allows you to configure the North Bridge Chipset.



USB Configuration

USB configuration settings

PCH Azalia Configuration

PCH Azalia configuration settings

PCH LAN Controller

Enable or disable onboard NIC.

Wake on LAN

Enable or disable integrated LAN to wake the system. (The Wake On LAN cannot be disabled if ME is on at Sx state.)

PCIE LAN Controller

Enable or disable onboard PCIE LAN

Wireless LAN Controller

Enable or disable onboard MPCIE LAN-Wireless LAN.

SLP_S4 Assertion Width

Select a minimum assertion width of the SLP_S4# signal.

Restore AC Power Loss

Select AC power state when power is re-applied after a power failure.

RI Wake Up

RI wake up function select.

Watch Dog Function select

Watch Dog function enabled or disabled.

4.5.1.1 USB Configuration



XHCI Pre-Boot Driver

Enable or disable XHCI Pre-Boot driver support.

XHCI Mode

Mode of operation of XHCI controller

HS Port #1/2/3/4 Switchable

Allows for HS port switching between xHCI and EHCI. If disabled, port is routed to EHCI. If HS port is routed to xHCI, the corresponding SS port is enabled.

xHCI Streams

Enable or disable xHCI Maximum Primary Stream Array Size.

EHCI1/2

Control the USAB EHCI (USB 2.0) functions. One EHCI controller must always be enabled.

USB Ports Per-Port Disable Control

Control each of the USB ports (0~13) disabling.

4.5.1.2 PCH Azalia Configuration

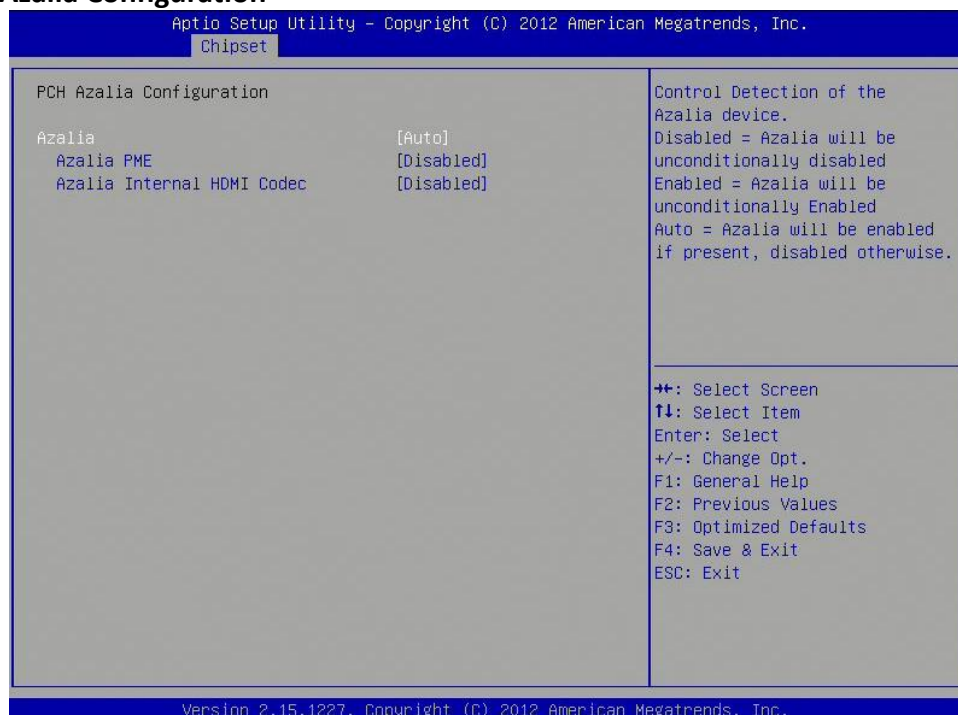

Azalia

Control Detection of the Azalia device.

Disabled=Azalia will unconditionally disabled.

Enabled=Azalia will be unconditionally enabled.

Auto=Azalia will enabled if present, disabled otherwise.

Azalia PME

Enable or disable Power Management capability of audio controller.

Azalia Internal HDMI codec

Enable or disable internal HDMI codec for Azalia.

4.5.2 System Agent (SA) Configuration

This section is used to configure the System Agent (SA) configuration.

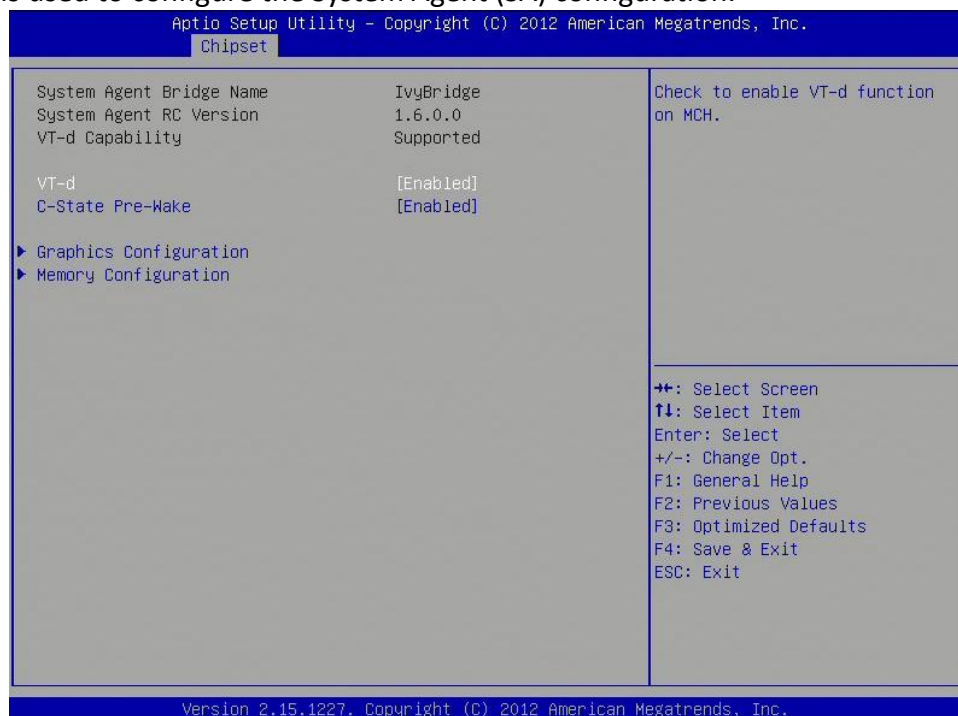

VT-d

Check to enable VT-d function on MCH.

Enable NB CRID

Enable or disable NB CRID WorkAround.

C-State Pre-Wake

Controls C-State Pre-Wake feature for ARAT, in SSKPD[57].

Graphics Configuration

Configure graphics settings

Memory Configuration

Memory configuration parameters

4.5.2.1 Graphics Configuration

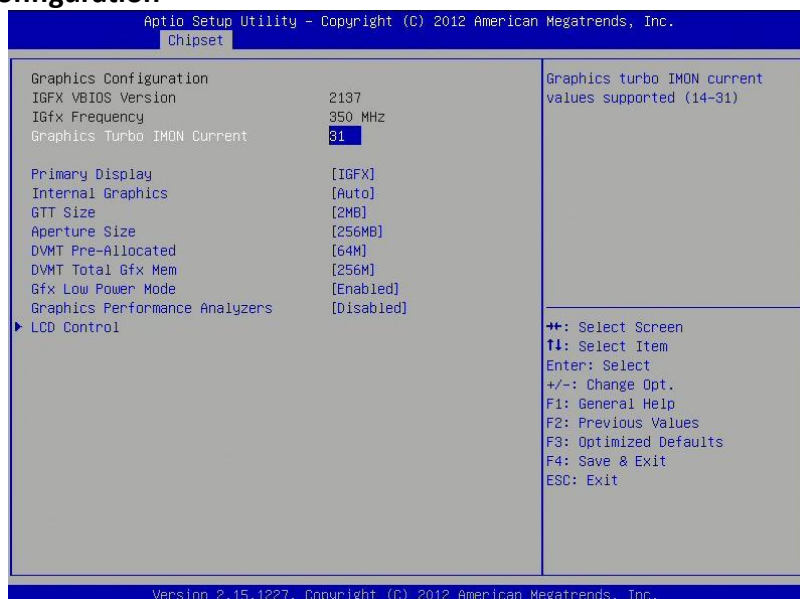

Primary Display

Select which of IGFX/PEG/PCI graphics device should be primary display or select SG for switchable Gfx.

Internal Graphics

Keep IGD enabled based on the setup options.

DVMT Pre-Allocated

Select DVMT 5.0 Pre-Allocated (Fixed) graphics memory size used by the internal graphics device.

DVMT Total Gfx Mem

Select DVMT 5.0 total graphics memory size used by the internal graphics device.

Gfx Low Power Mode

This option is applicable for SFF only.

Graphics Performance Analyzers

Enable or disable Intel graphics performance analyzers counters.

4.5.2.2 Memory Configuration

Apdio Setup Utility - Copyright (C) 2012 American Megatrends, Inc.
Chipset

<p>Memory Information</p> <p>Memory RC Version 1.6.0.0 Memory Frequency 1333 Mhz Total Memory 2048 MB (DDR3) DIMM#0 2048 MB (DDR3) DIMM#1 Not Present CAS Latency (tCL) 9 Minimum delay time CAS to RAS (trCDmin) 9 Row Precharge (trPmin) 9 Active to Precharge (tRASmin) 24 XMP Profile 1 Not Supported XMP Profile 2 Not Supported</p> <p>DIMM profile [Default DIMM profile] Memory Frequency Limiter [Auto] Max TOLUD [Dynamic] NMode Support [Auto] Memory Scrambler [Enabled] MRC Fast Boot [Enabled] Force Cold Reset [Enabled] DIMM Exit Mode [Fast Exit] Power Down Mode [PPD] Scrambler Seed Generation Off [Disabled]</p>	<p>▲ Select DIMM timing profile that should be used.</p> <hr/> <p>↔: Select Screen ↑↓: Select Item Enter: Select +/-: Change Opt. F1: General Help F2: Previous Values F3: Optimized Defaults F4: Save & Exit ESC: Exit</p>
---	---

Version 2.15.1227. Copyright (C) 2012 American Megatrends, Inc.
Apdio Setup Utility - Copyright (C) 2012 American Megatrends, Inc.
Chipset

<p>Total Memory 2048 MB (DDR3) DIMM#0 2048 MB (DDR3) DIMM#1 Not Present CAS Latency (tCL) 9 Minimum delay time CAS to RAS (trCDmin) 9 Row Precharge (trPmin) 9 Active to Precharge (tRASmin) 24 XMP Profile 1 Not Supported XMP Profile 2 Not Supported</p> <p>DIMM profile [Default DIMM profile] Memory Frequency Limiter [Auto] Max TOLUD [Dynamic] NMode Support [Auto] Memory Scrambler [Enabled] MRC Fast Boot [Enabled] Force Cold Reset [Enabled] DIMM Exit Mode [Fast Exit] Power Down Mode [PPD] Scrambler Seed Generation Off [Disabled] Memory Remap [Enabled] Memory Alias Check [Disabled] Channel A DIMM Control [Enable Both DIMMS] Channel B DIMM Control [Enable Both DIMMS]</p>	<p>▲ Enable or disable dimms on Channel B.</p> <hr/> <p>↔: Select Screen ↑↓: Select Item Enter: Select +/-: Change Opt. F1: General Help F2: Previous Values F3: Optimized Defaults F4: Save & Exit ESC: Exit</p>
--	---

Version 2.15.1227. Copyright (C) 2012 American Megatrends, Inc.

4.6 Boot Setting

This section is used to configure the boot features.

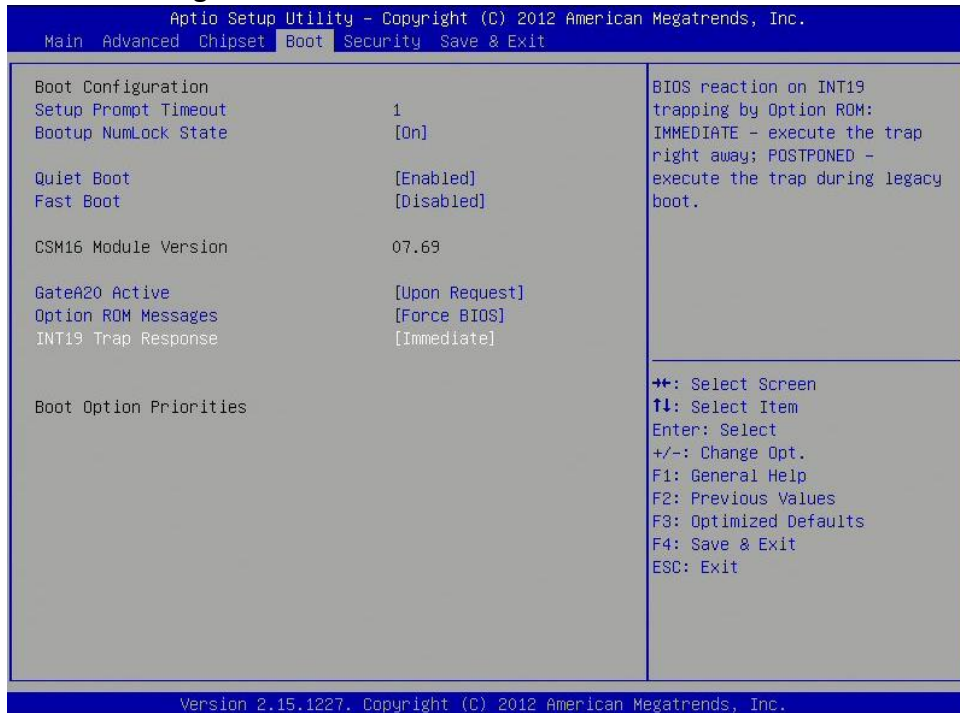

Setup Prompt Timeout

Number of seconds to wait for setup activation key. 65535(0xFFFF) means indefinite waiting.

Bootup NumLock State

Select the keyboard NumLock state.

Quiet Boot

Enables or Disables Quiet Boot option.

Fast Boot

Enables or Disables boot with initialization of a minimal set of devices required to launch active boot option. Has no effect for BBS boot options.

GateA20 Active

UPON REQUEST – GA20 can be disabled using BIOS services.
ALWAYS – do not allow disabling GA20; this option is useful when any RT code is executed above 1MB.

Option ROM Messages

Set display mode for Option ROM.

INT19 Trap Response

BIOS reaction on INT19 trapping by Option ROM: IMMEDIATE – execute the trap right away; POSTPONED – execute the trap during legacy boot.

Boot Option Priorities

Sets the system boot order.

4.7 Security

Use the Security Menu to establish system passwords

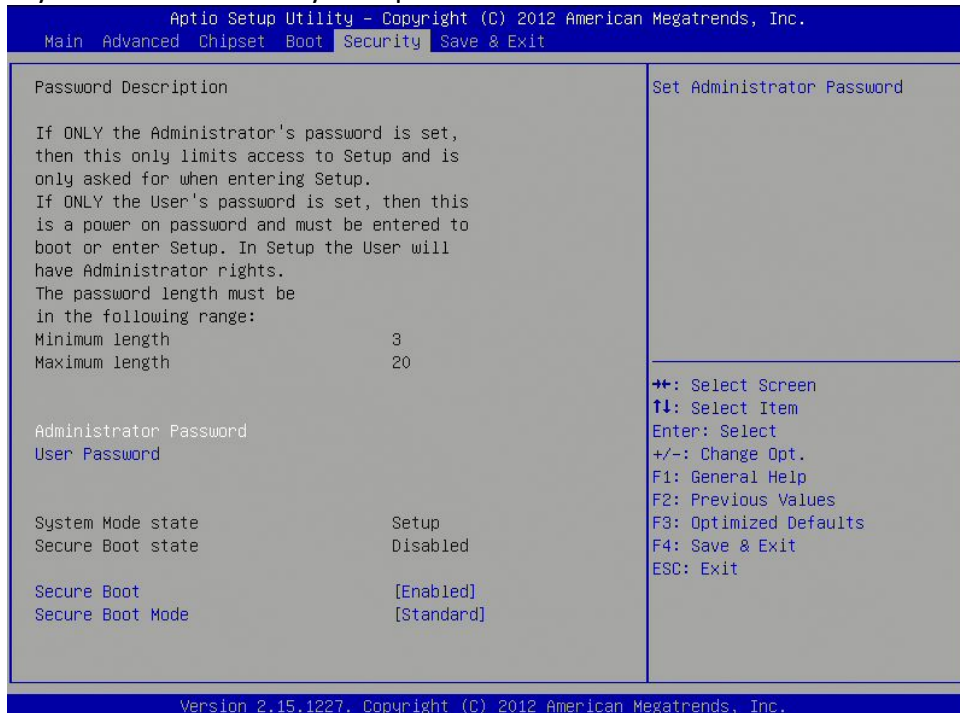

Administrator Password

Set administrator password.

User Password

Set User Password.

Secure Boot

Secure boot flow control. Secure boot is possible only if system runs in user mode.

Secure Boot Mode

Secure boot mode selector. 'Standard' – fixed secure boot policy, 'custom' – changeable image execution policy and secure boot key databases.

4.8 Save and exit

This screen provides functions for handling changes made to the BIOS settings and the exiting of the Setup program.



Save Changes and Exit

Exit system setup after saving the changes.

Restore Defaults

Restore or Load Defaults values for all the setup options.